

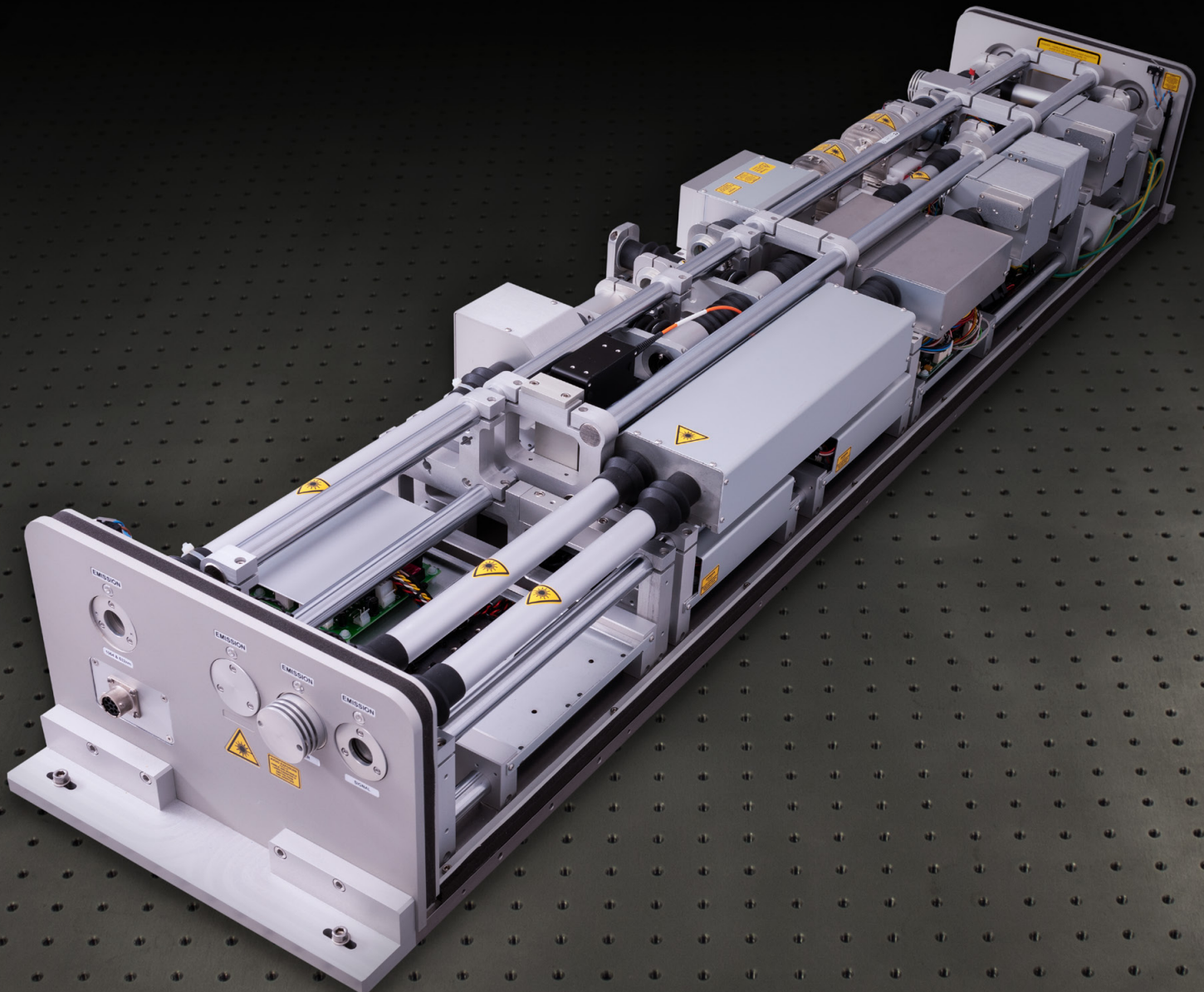

TUNABLE PULSED LASERS

Integrated Nd:YAG pumped type II BBO OPO laser systems

2 0 2 4



Aurora II Integra OPO

Innovative, Type II BBO OPO and Nd:YAG pump laser integrated into a single system

The **Aurora II** range of type II BBO OPOs has been designed for reliability, stability and ease of use. The OPO and pump source are supplied as a fully integrated solution. With a wide choice of integrated and optimised Nd:YAG pump lasers from 10Hz to 100Hz, these are truly flexible systems.

Fully featured computer control of both the pump laser and OPO ensures ease of use and simple system integration. Integrators will benefit from the unprecedented flexibility and usability of this system. Researchers will appreciate its modularity and how the many possible upgrades can support their changing research objectives.



FEATURES

- **Fully integrated Q-switched pump laser and OPO**
- **Continuous tuning range of 410nm – 2600nm**
- **Pulse energies up to 65mJ**
- **< 4cm⁻¹ linewidth in the visible range**
- **No user alignment required**
- **Repetition rates up to 100Hz**
- **Automatic beam position compensation**
- **Motorised OPO wavelength tuning**
- **Simultaneous signal and idler access**
- **355nm pump process shutter and energy monitoring**
- **Full PC control**
- **Pump beam attenuation**
- **Access to 355nm pump output via the front panel**

OPTIONS INCLUDE

- **UV extended range for 210nm – 410nm**
- **Spectrometer for wavelength measurement and automatic tuning**
- **OPO attenuator**
- **Access to 1064nm and 532nm via side ports**
- **Variable repetition rates**
- **532nm pumping for high energy 670nm – 2600nm operation**

APPLICATIONS

- **Photoacoustic Imaging**
- **Laser Induced Fluorescence**
- **Photobiology**
- **High Resolution Spectroscopy**
- **Non Linear Spectroscopy**
- **LIDAR & Remote Sensing**
- **LIDT**
- **Process Monitoring**
- **Combustion Research**
- **Display Manufacture and Testing**

Aurora II Type II BBO OPO Unit Schematic view

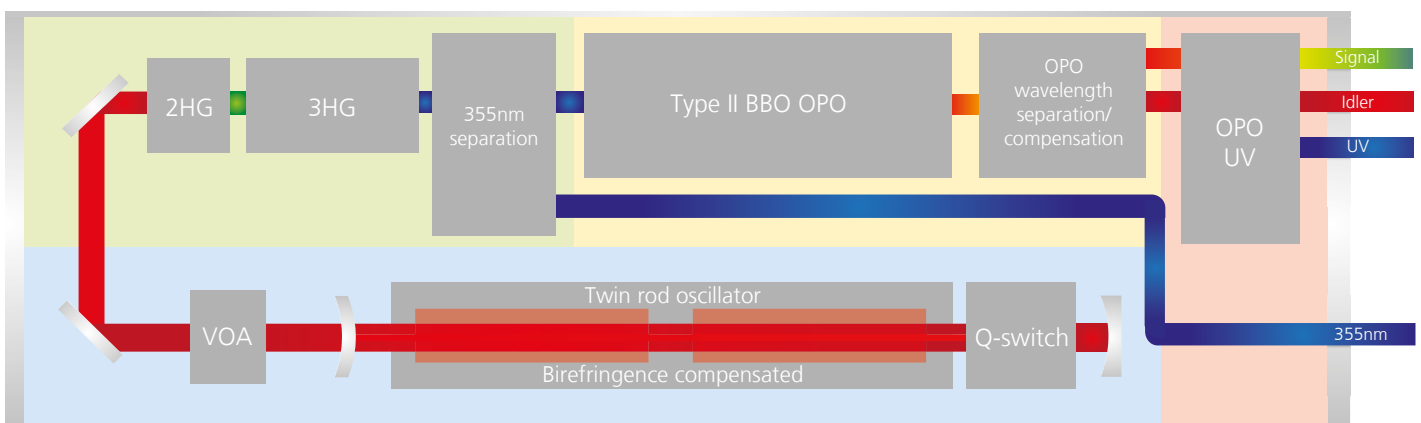

Twin rod Nd:YAG oscillator and variable attenuator

532nm and 355nm harmonic generation and separation

Type II BBO OPO and separation optics

Optional OPO UV generation

Schematic shows the compact arrangement of the combined pump laser and Aurora II 355 OPO in a single housing.

Aurora II 355 OPO

The entire system requires no user adjustment due to the integrated Invar optical rail construction delivering excellent output stability as standard. Auto-stabilisation and auto-tuning of the 355nm pump laser provide an additional level of automation and long-term stability control for continuous operation and industrial applications. The Aurora II uses a highly modular system component design that is suitable for customised solutions tailored to the user's individual needs.



Wavelengths are available in a continuously tunable range from 410nm to 2600nm and this can be extended to 210nm with a rail-mounted, internal UV module. The fundamental and harmonic outputs can be separated outside of the laser head, for simultaneous access to both, or separated inside the head with the optional Pellin Broca module, to give UV-only output from the laser head.

High efficiencies are achieved by employing a double-pass pump configuration in an elegant and yet robust design. The reliability is further enhanced by using coated and temperature-stabilised crystals in a sealed housing to ensure the longevity of the system. Changes in the crystal tuning angle lead to small changes in the beam direction due to beam translation, so compensation for beam translation is provided as standard to maintain the output beam direction, which is useful in pointing-sensitive applications such as fibre coupling.

Both the pump laser and OPO are controlled and tuned via the intuitive computer interface that adjusts the angle of the BBO crystal using high-resolution stepper motors. A factory-programmed look-up table provides fast and reliable adjustment of the OPO crystal angle, to achieve the specified wavelength with the optional built-in spectrometer providing wavelength confirmation, calibration and closed-loop tuning.

TECHNICAL DATA

Model	Aurora II 355				Model	
	20-10	45-10	65-10	40-20		
OPO Wavelength Range					Air*	
Signal (nm)	410-710	410-710	410-710	410-710	Max. air temp (°C)	35
Idler (nm)	710-2600	710-2600	710-2600	710-2600	Min. air temp (°C)	5
SH generator (nm)	210-410	210-410	210-410	210-410	Humidity (% , non-condensing)	0-80
					Ambient heating (kW)	<2
OPO Output Pulse Energy					Water*	
OPO (mJ) ⁽¹⁾	20	45	65	40	Max water temp (°C)	20
UV generator (mJ) ⁽²⁾	2	4	6	⁽³⁾	Nominal flow rate (lpm)	4-6
OPO Parameters					Min. water pressure (Bar [psi])	2 [30]
Linewidth (cm ⁻¹) ⁽⁴⁾	<3	<3	<3	<3	Max. water pressure (Bar [psi])	4.5 [65]
Pulse stability (RMS %) ⁽⁵⁾	<4	<4	<4	<6		
Pulse width (ns) ⁽⁶⁾	4-7	4-7	4-7	4-7		
Beam diameter (mm) ⁽⁷⁾	5	5	6	5		
OPO Scanning Step ⁽⁸⁾						
Signal (nm)	~0.01	~0.01	~0.01	~0.01		
Idler (nm)	~0.5	~0.5	~0.5	~0.5		
OPO Polarisation						
Signal beam	vertical	vertical	vertical	vertical		
Idler beam	horizontal	horizontal	horizontal	horizontal		
Pump Laser						
Repetition rate (Hz)	10	10	10	20		
Pump wavelength (nm)	355	355	355	355		
Pulse width (ns)	6-10	6-10	6-10	6-10		
Services						
Voltage (VAC)	220-250	220-250	220-250	220-250		
Frequency (Hz)	50/60	50/60	50/60	50/60		
Power phase	single	single	single	single		
Operating amb. temp (°C)	5-35	5-35	5-35	5-35		
Laser cooling*	Air	Air	Air	Water		

- (1) Signal typically at 450nm. See graphs on page 4 for output at other wavelengths.
- (2) Signal typically at 260nm.
- (3) Contact Litron for more information.
- (4) Linewidth <3cm⁻¹ for 450nm < λ < 710nm. < 8cm⁻¹ for 255nm < λ < 355nm range.
- (5) RMS % stability at 450nm. See graph on page 4 for stability at other wavelengths.
- (6) FWHM – measured with fast photodiode and 300MHz oscilloscope.
- (7) Near field, based on pump diameter, 1/e² at 450nm.
- (8) Typical values, scanning step size varies with wavelength.

SYSTEM PERFORMANCE

Example signal output over tuning range 410-710nm

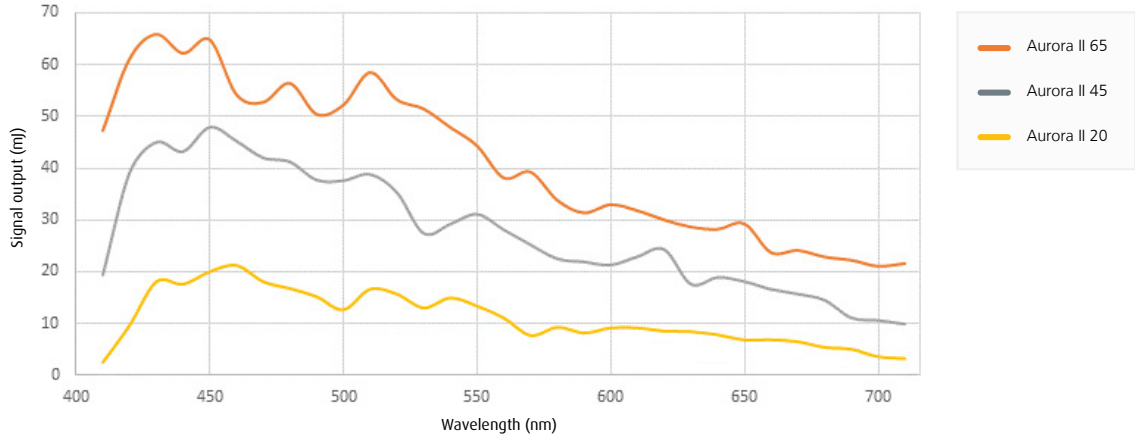

Example idler output over tuning range 710-2600nm

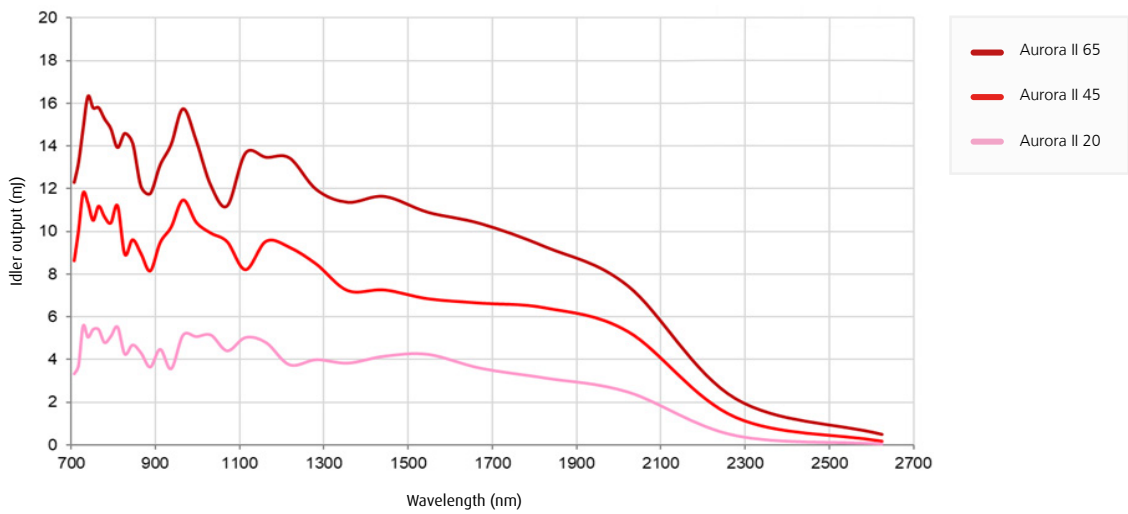

OPO signal linewidth

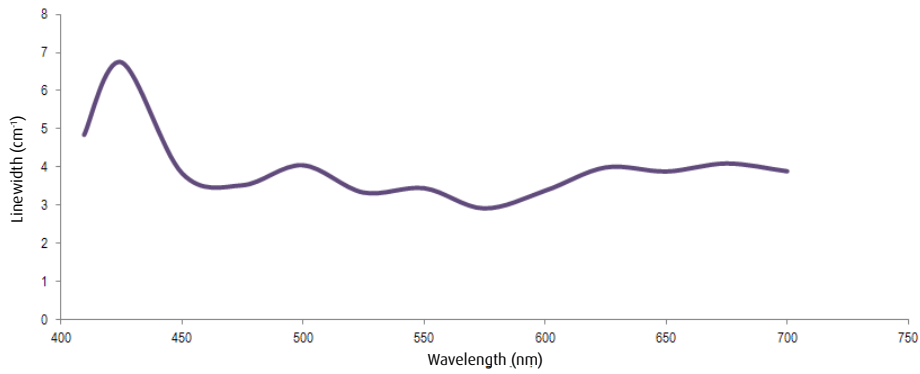

OPO stability

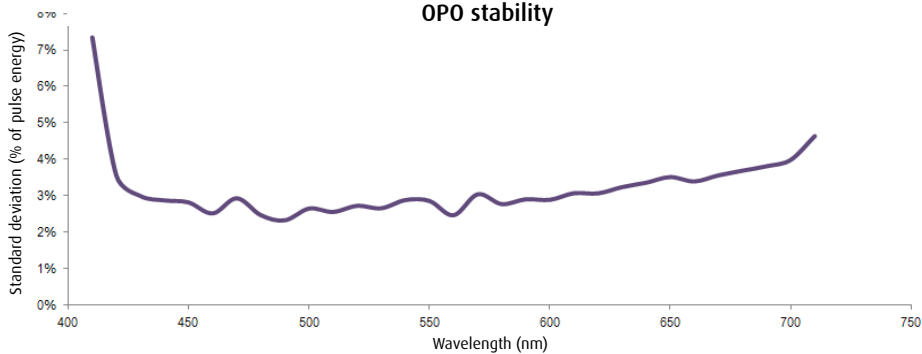

Aurora UV Module

Extending Access to UV Wavelengths

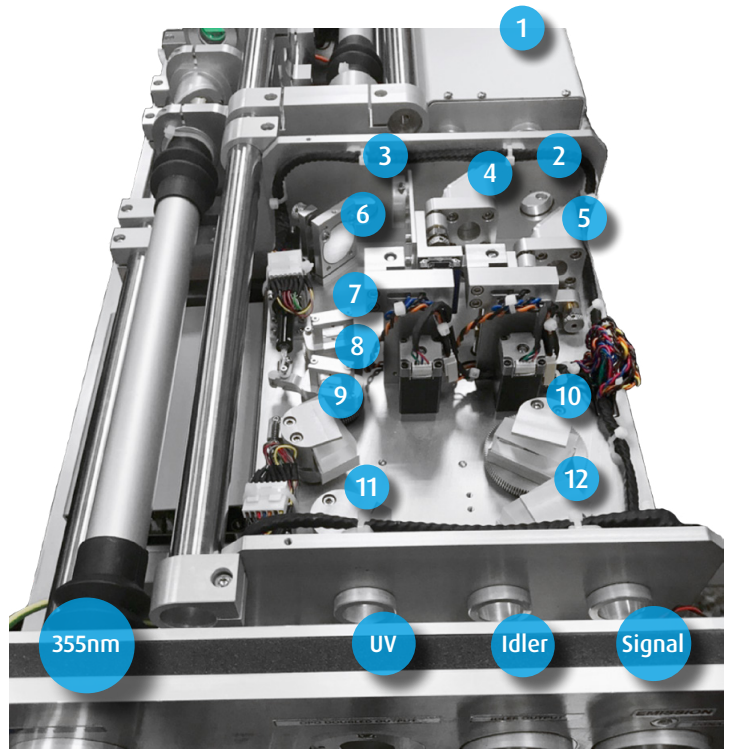
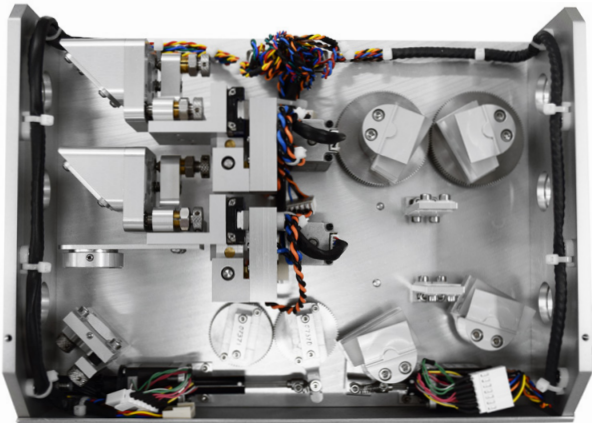

The fully integrated and motorised Aurora UV module is controlled via the standard software for simple, responsive control. A spectrometer, internally mounted inside the head, provides closed-loop feedback to automatically tune to the selected wavelength, or the user can tune manually.

The UV range from 210nm to 410nm is generated by frequency doubling of the signal (2) and idler (3) beams. Both the signal and idler have separate motorised mirror movers (4 & 5) which allow both beams to exit from the front port of the laser or, alternatively, be diverted (6) through the UV doubler (7 & 8).

A motorised four prism arrangement (9-12) with internal beam blocks is used to separate the UV from the fundamental wavelength. Pellin-Broca prisms used in this way give a very pure separation of the wavelengths. The unit also allows for fine optimisation of crystal and prisms for maximum energy and accurate positioning of the output beam.

- 1 - OPO
- 2 - signal output from OPO
- 3 - idler output from OPO
- 4 & 5 - mirror movers
- 6 - steering mirror
- 7 & 8 - doubling crystals
- 9-12 - motorised Pellin-Broca separators

Example UV output over tuning range 210-410nm

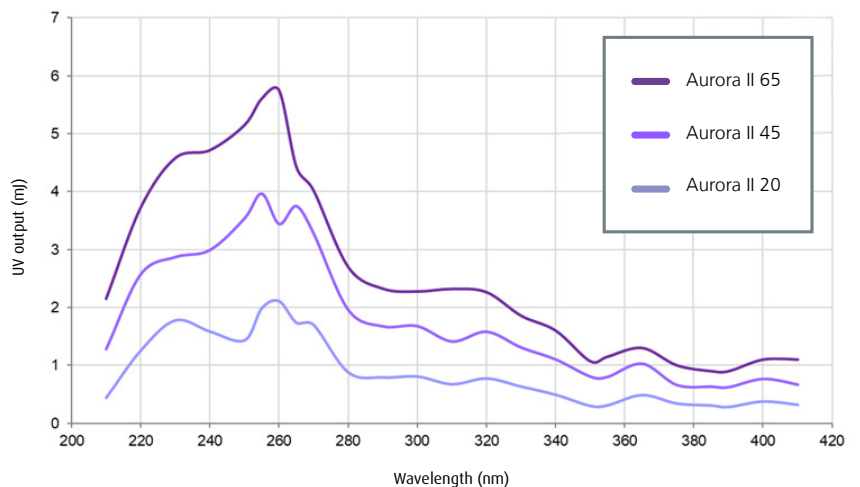

Aurora OPO Attenuator

The OPO Attenuator module is external to the OPO, and can be used to attenuate both signal and idler outputs. It can be retrofitted to existing systems.



Aurora motorised optical attenuator

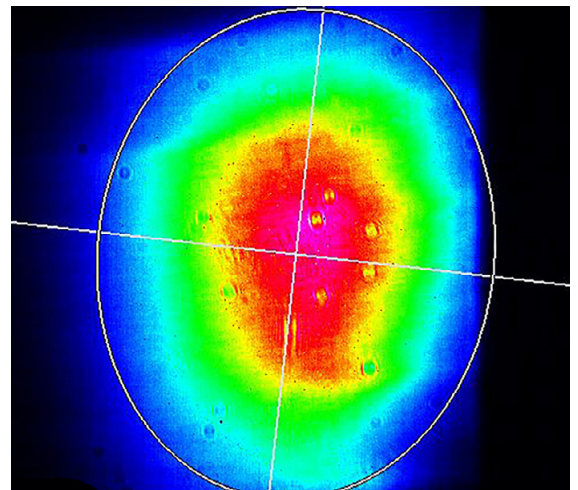

Example 470nm beam profile

Aurora II 355 DPSS OPO

Fully integrated OPO and DPSS Nd:YAG laser

The **Aurora II 355 DPSS OPO** is a 355nm pumped fully integrated package. It combines all of the standard Aurora features, including no-gap tuning and type II phase matching, with long lifetime and high repetition rate DPSS performance.

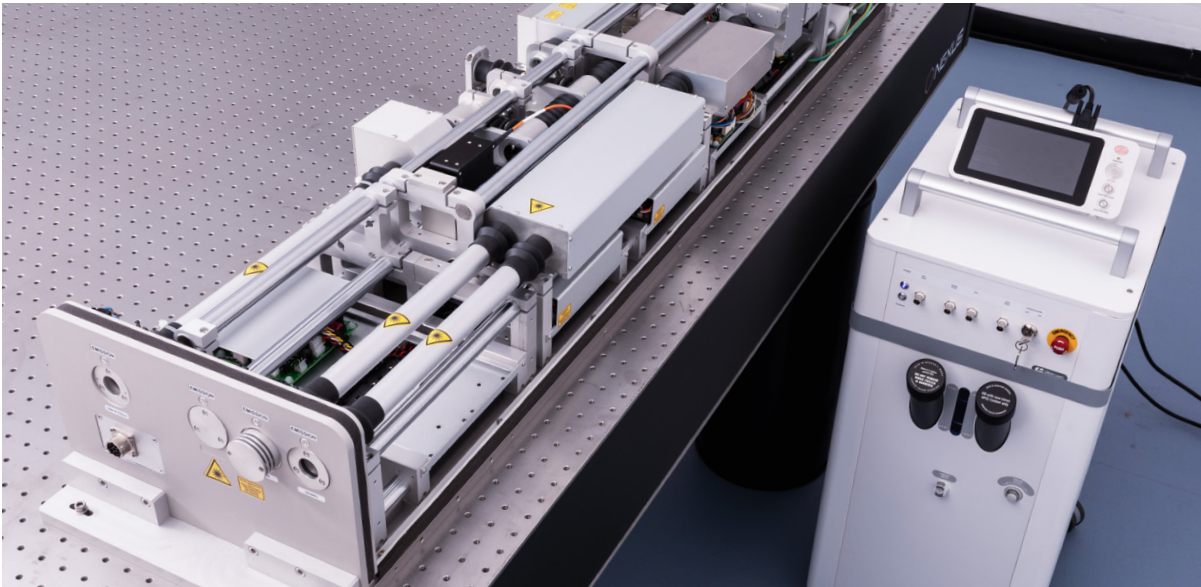

FEATURES

- **Long diode lifetime**
- **Motorised tuning and optimisation of pump energy**
- **Closed-loop wavelength tuning programmable via software**
- **Customisable design**
- **Rugged and stable construction**
- **Optional tuning of UV wavelengths**
- **Onboard high resolution spectrometer option**
- **OPO attenuator**

APPLICATIONS

- **Photoacoustic Imaging**
- **Laser Induced Fluorescence**
- **Photobiology**
- **Spectroscopy**
- **LIDAR & Remote Sensing**
- **LIDT**
- **Process Monitoring**
- **Display Manufacture and Testing**

TECHNICAL DATA

Model	Aurora II 355 10-100
OPO Wavelength Range ⁽¹⁾	
Signal (nm)	410-710
Idler (nm)	710-2600
SH Generator (nm)	210-410
OPO Parameters	
OPO Output Pulse Energy @ 100Hz (mJ) ⁽²⁾	8
Linewidth (cm ⁻¹) ⁽³⁾	<3
Pulse Stability (RMS %) ⁽⁴⁾	<4
Scanning Step Signal / Idler (nm)	~0.01/~0.5
Pulse Width (ns) ⁽⁵⁾	4-7
Beam Diameter (mm) ⁽⁶⁾	5
Pump Laser Parameters	
Beam Divergence (mrad)	0.9
M ² @ 1064nm	≤8
Pointing Stability (μrad) ⁽⁷⁾	≤15
Timing Jitter (ns) ⁽⁸⁾	≤0.5
Polarisation	Linear

All specifications at maximum repetition rate unless otherwise stated.

- (1) Optional hands-free tuning range 210nm-2600nm.
- (2) Signal at 450nm.
- (3) Linewidth <3cm⁻¹ for 450nm < λ <710nm. 2HG linewidth <6cm⁻¹ for 255nm < λ <355nm range.
- (4) RMS % stability at 450nm.
- (5) FWHM - measured with fast photodiode and 300MHz oscilloscope.
- (6) Measured near field 1/e² diameter at 450nm.
- (7) Half angle.
- (8) RMS with respect to Q-switch trigger input.

EXAMPLE OUTPUTS

Output with 100Hz DPSS pump laser

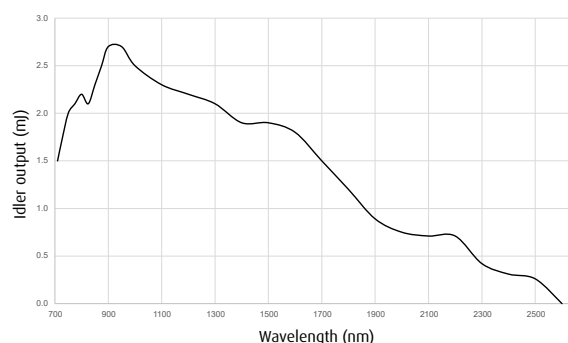
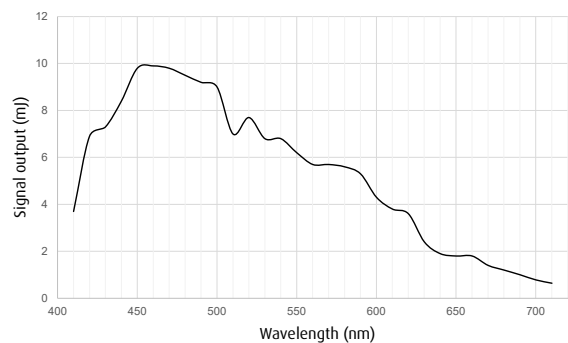

Aurora II 532 OPO

Pulsed Nd:YAG high energy compact laser and 532nm-pumped OPO

FEATURES

- **Modular OPO for TRLi lasers**
- **10 - 200Hz repetition rate**
- **Tuning range 670 – 2600nm**
- **Linewidth 2-6cm⁻¹**
- **Motorised OPO tuning**
- **Full PC control via RS232**
- **Built-in pump attenuator**
- **Fibre coupling option**
- **Extended range option (335 – 650nm)**
- **Ultra high stability pump laser <0.3% RMS**
- **Motorised auto-tuning of pump laser**



Aurora II 532 OPO, flashlamp or DPSS

The **Aurora II 532 OPO** combines a 532nm pump generator, variable attenuator and Type II BBO OPO into a single compact module that can be attached to any of Litron's TRLi series of Nd:YAG lasers to provide tunable no-gap output in the 670nm to 2600nm range. An alternative OPO mirror set optimises the output for 700nm to 900nm.

Incorporating design features used throughout Litron's Aurora OPOs, the TRLi module provides high stability, narrow line width and simultaneous signal and idler output in a self-contained unit that is interchangeable with the harmonic units within the TRLi range. With little to no realignment required on reattachment, the Aurora II 532 OPO expands the output of these high energy compact lasers into the NIR range without losing the flexibility of accessing the Nd:YAG harmonics. Alternatively, an Invar-stabilised version is available for industrial applications (Aurora II Compact 532 DPSS OPO).

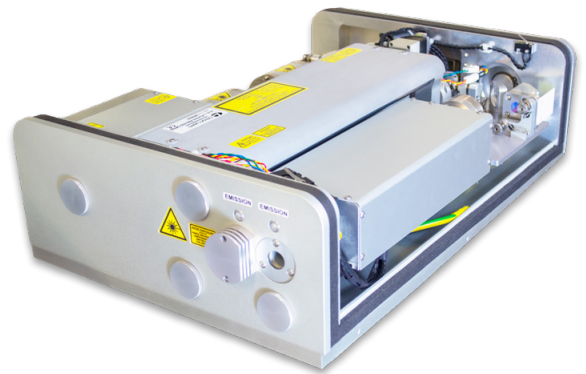

Aurora II Compact 532 DPSS OPO

Aurora II OPO can be provided with a flashlamp or diode pumped source.

TECHNICAL DATA

Model	Aurora II 532	Aurora II DPSS 532
OPO Wavelength Range Signal (nm) Idler (nm) Extended Range (nm)	670-1064 1064-2600 335-650	670-1064 1064-2600 335-650
OPO Output Pulse Energy OPO (mJ) at 840nm 10Hz 100Hz 200Hz	up to 110	up to 30 up to 20
OPO Parameters Linewidth (cm ⁻¹) Output Stability (RMS %) Pulse Width (ns)	2-6 ≤2 4-7	2-6 ≤2 4-7
Pump Laser Repetition rate (Hz) Pump Wavelength (nm)	Lamp Pumped 10-50 532	Diode Pumped 50-200 532
Services Voltage (VAC) Frequency (Hz) Power phase Operating amb temp (°C) Laser cooling	220-250 50/60 Single 10-30 Air/Water or Water	220-250 50/60 Single 10-30 Chiller

EXAMPLE OUTPUTS

Output with 10Hz flashlamp operation

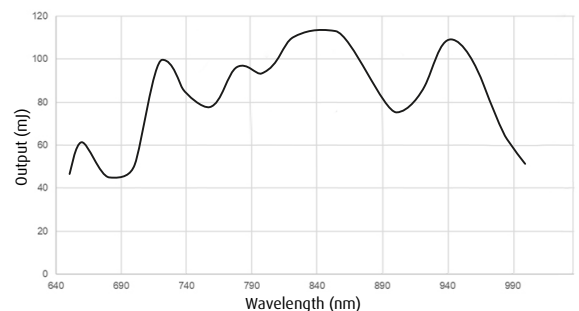

Output with 100Hz DPSS operation

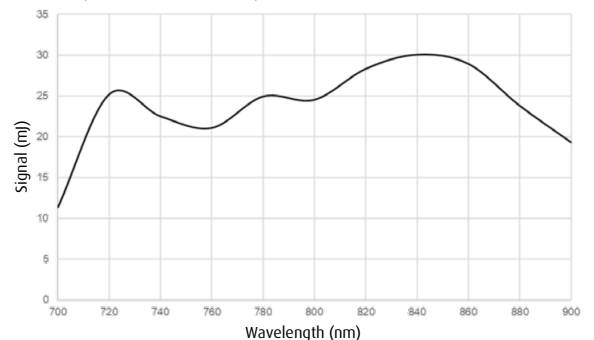

MECHANICAL DATA

All dimensions in mm unless stated

Aurora II 355 OPO

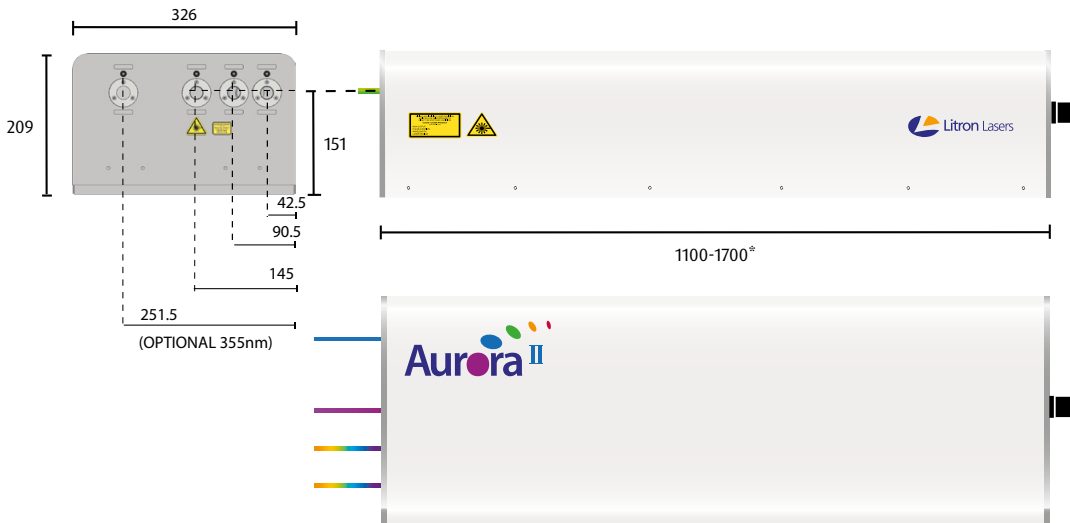

Dimensions		
Laser Head	(mm)	326 (W) x 209 (H) x 1100* (L)
	(inches)	12.8 (W) x 8.2 (H) x 43.3* (L)
PSU LPU1000	(mm)	238.5 (W) x 615 (H) x 502 (L)
	(inches)	9.4 (W) x 24.2 (H) x 19.7 (L)
PSU 16U Rack	(mm)	605 (W) x 617 (H) x 700 (L)
	(inches)	23.8 (W) x 24.3 (H) x 27.5 (L)

* Depending on laser system options

Aurora II 532 OPO

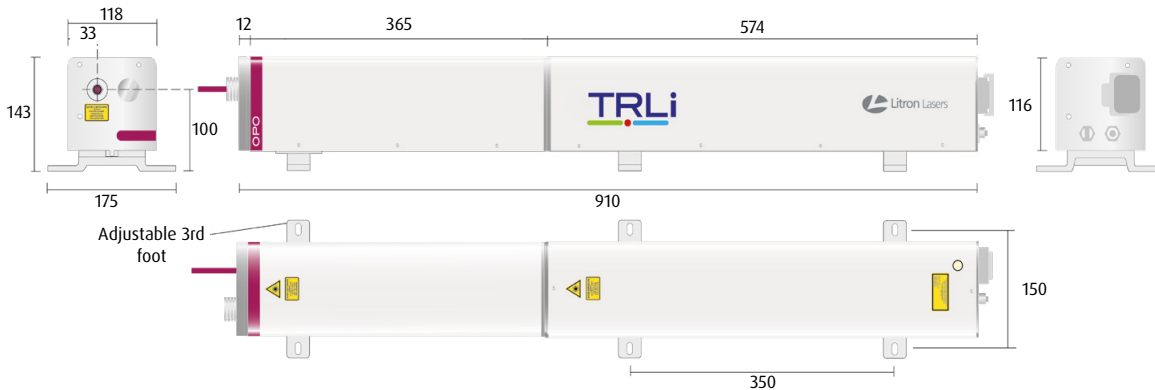

Dimensions		
Laser Head	(mm)	118* (W) x 143 (H) x 951* (L)
	(inches)	4.6* (W) x 5.6 (H) x 37.4* (L)
PSU LPU1000	(mm)	238.5 (W) x 615 (H) x 502 (L)
	(inches)	9.4 (W) x 24.2 (H) x 19.7 (L)
PSU 16U Rack	(mm)	605 (W) x 617 (H) x 700 (L)
	(inches)	23.8 (W) x 24.3 (H) x 27.5 (L)
PSU/Chiller for DPSS	(mm)	370 (W) x 800 (H) x 500 (L)
	(inches)	14.6 (W) x 31.5 (H) x 19.7 (L)

* Depending on laser system options

Free standing PSU and chiller

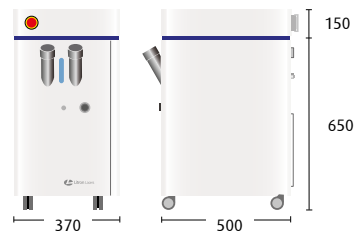

Our policy is to improve the design and specification of our products. The details given in this document are not to be regarded as binding.



Litron Lasers Ltd
8 Consul Road, Rugby,
Warwickshire CV21 1PB England.

T +44 (0)1788 574444
F +44 (0)1788 574888
E sales@litron.co.uk

