



Features and Benefits

- **‘Standalone’ Beryllium window** *1
200 µm thick Beryllium foil window as standard
- **TE cooling down to -100°C**
Critical for elimination of dark current
- **UltraVac™**
Critical for sustained vacuum integrity and to maintain unequalled cooling, year after year
- **Peak QE of 95%**
High detector sensitivity
- **13 x 13 µm pixel size**
Optimal balance of dynamic range and resolution
- **Ultra-low noise readout**
Intelligent low-noise electronics offer the most ‘silent’ system noise performance available
- **Multi-Megahertz pixel readout**
High frame rates achievable (5 MHz in visualization mode, 50 kHz for the highest sensitivity and signal-to-noise ratio)
- **Enhanced baseline clamp**
Quantitative accuracy of dynamic measurements
- **Cropped sensor mode**
Specialized acquisition mode for continuous imaging with fast temporal resolution
- **USB 2.0 connection**
USB plug and play – no controller box
- **Integrated in EPICS**
Platform is fully integrated into the EPICS control software

‘Standalone’ Soft X-ray Imaging @ -100°C

Andor’s standalone USB 2.0 iKon-M SY 934 series feature a high-QE, back-illuminated, soft X-ray optimized sensor for direct X-ray detection and is ideal for low flux, low photon energy research. A convenient Beryllium foil window blocks visible wavelengths with minimal ‘Beam Hardening’ of lower energy X-rays.

This 1024 x 1024 sensor array with 13 x 13 µm pixels offers high dynamic range and high spatial resolution. Seamless software selection of a range of kHz and Multi-MHz readout speeds provide exceptionally low readout noise and faster frame rates respectively.

Specifications Summary

Active pixels	1024 x 1024
Sensor size	13.3 x 13.3 mm
Pixel size (W x H)	13 x 13 µm
Active area pixel well depth (typical)	100,000 e ⁻
Maximum readout rate	5 MHz
Read noise	2.9 e ⁻
Maximum cooling	-100°C
Frame rate	4.4 fps (full frame)
Beryllium foil thickness	200 µm

High Energy Detection

Key Specifications

Model number	DY934P	DY934P-BR-DD
Sensor options	<ul style="list-style-type: none"> • BN: Back illuminated sensor - no AR coating • FI: Front illuminated sensor 	<ul style="list-style-type: none"> • BR-DD: Back Illuminated, Deep Depletion CCD with fringe suppression
Active pixels *2	1024 x 1024	
Pixel size	13 x 13 μm	
Image area	13.3 x 13.3 mm with 100% fill factor	
Minimum temperatures *3		
Air cooled	-80°C	
Coolant recirculator	-95°C	
Coolant chiller, coolant @ 10°C, 0.75l/min	-100°C	
Blemish specification	Grade 1 sensor from supplier. Camera blemishes as defined by Andor Grade A: https://andor.oxinst.com/learning/view/article/ccd-blemishes-and-non-uniformities	

Advanced Specifications*4

Dark current, e ⁻ /pixel/sec *5 @ -100°C	0.00012	0.00047
Pixel readout rates	5, 3, 1, 0.05 MHz	
Output node capacity	250,000 e ⁻	
Pixel well depth	100,000 e ⁻	130,000 e ⁻
Read noise (e ⁻) *6		
0.05 MHz	2.9	3.7
1 MHz	6.6	6.6
3 MHz	11.6	10.0
5 MHz *9	18.0	15.0
Linearity *7	Better than 99%	
Digitization	16-bit	
Vertical clock speed	11.3 to 67.3 μs (software selectable)	4.25 to 64.25 μs (software selectable)

Frame Rates*8

50 kHz Precision photometry mode				
Binning	Full Frame	512 x 512	256 x 256	128 x 128
1 x 1	0.04	0.1	0.2	0.4
2 x 2	0.2	0.2	0.4	0.8
4 x 4	0.6	0.6	0.9	1.5
8 x 8	2	1.2	1.7	2.8
16 x 16	5.1	2.3	3.2	5

1 MHz				
Binning	Full Frame	512 x 512	256 x 256	128 x 128
1 x 1	0.9	1.8	3.5	6.9
2 x 2	2.9	4.3	7.5	13.5
4 x 4	7.9	9.4	14.8	24.6
8 x 8	18	18.2	26.6	40.7
16 x 16	33.4	31.6	43	59.8

3 MHz				
Binning	Full Frame	512 x 512	256 x 256	128 x 128
1 x 1	2.6	5.2	10	18.6
2 x 2	6.3	10.9	19.3	33.2
4 x 4	13.4	20.9	34.2	53.5
8 x 8	25.1	36.3	54.4	76.5
16 x 16	41.5	56.1	76.5	97.1

5 MHz Visualization mode*9				
Binning	Full Frame	512 x 512	256 x 256	128 x 128
1 x 1	4.4	8.5	16	28.8
2 x 2	8.4	15.9	28.5	47.6
4 x 4	15.6	28.1	47	70.8
8 x 8	27.3	45.8	69.4	93.5
16 x 16	43.6	66.9	91.2	111.5

Quantum Efficiency Curves ¹⁰

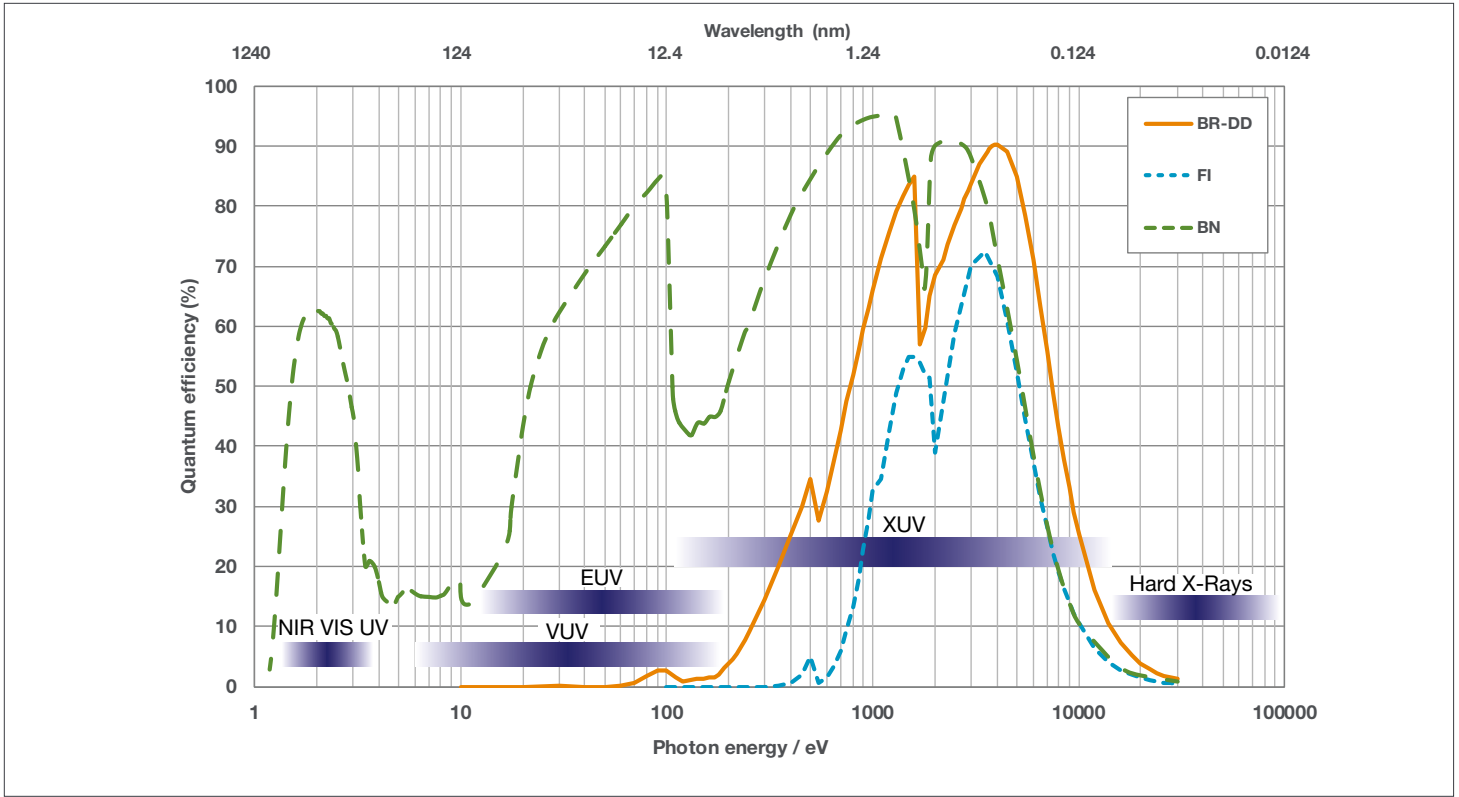

200 μm Beryllium Foil Transmission

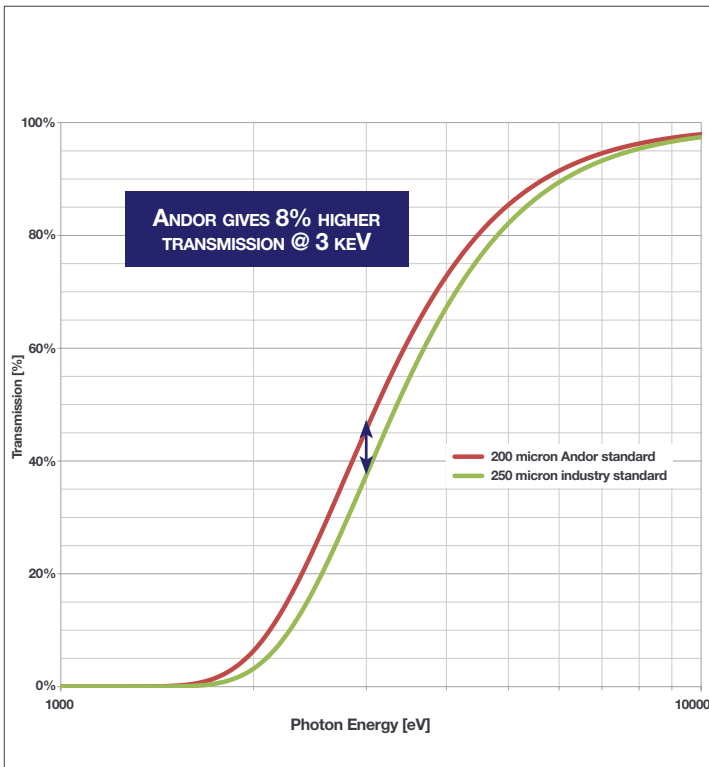

Photoelectrons v Incident X-rays ¹⁰

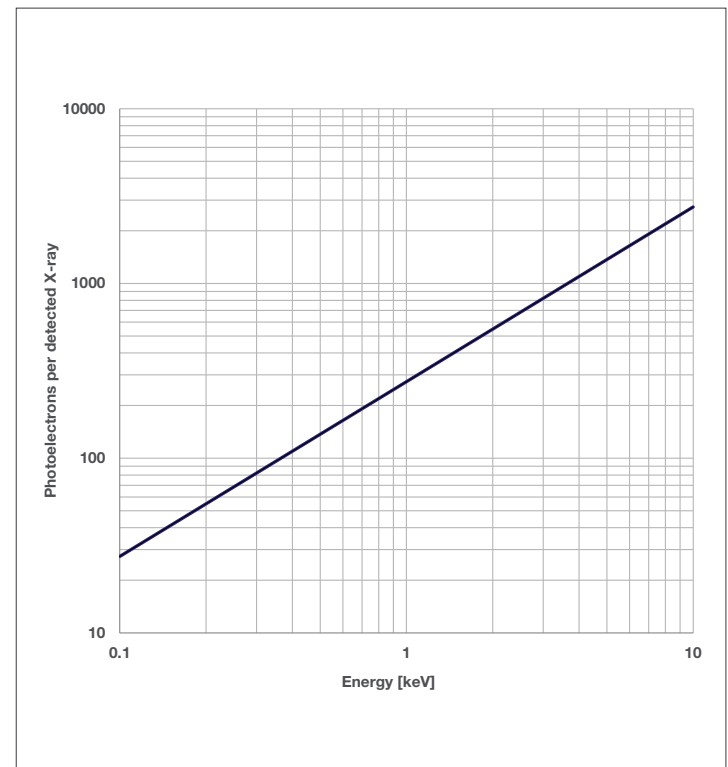

Creating The Optimum Product for You

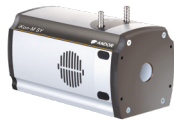

DY934P- **BR-DD** -T2
example shown

Step 1. Choose the sensor type option

Sensor Type	Description	Code
 Sensor Type	Back Illuminated CCD	#BN
	Back Illuminated, Deep Depletion CCD with fringe suppression and AR coating	BR-DD
	Front Illuminated CCD	FI

Step 2. Select the required accessories and adapters

Accessories & Adapters	Description	Order Code
	Re-circulator for enhanced cooling performance	XW-RECR
	Oasis 160 Ultra compact chiller unit (tubing to be ordered separately)	ACC-XW-CHIL-160
	6 mm tubing options for ACC-XW-CHIL-160 (2x2.5 m or 2x5 m lengths)	ACC-6MM-TUBING-2X2.5/ ACC-6MM-TUBING-2X5M
	USB Extender: Icron USB 2.0 Ranger 2201 (100 m) - EU/UK/US	ACC-USBX-EU ACC-USBX-UK ACC-USBX-US
	30 m Ethernet cable (for use with the above ACC-USBX-** USB extenders)	ACC-ELC-13295

A optional lockable USB connector and cable are also available on request.

Step 3. Select the required software

 **Software**

The iKon-M SY requires at least one of the following software options:

- Solis Imaging** A 32-bit and fully 64-bit enabled application for Windows (8, 8.1 and 10) offering rich functionality for data acquisition and processing. AndorBasic provides macro language control of data acquisition, processing, display and export.
- Andor SDK** A software development kit that allows you to control the Andor range of cameras from your own application. Available as 32/64-bit libraries for Windows (8, 8.1 and 10), compatible with C/C++, C#, Delphi, VB.NET, LabVIEW and Matlab. Linux SDK compatible with C/C++.

Have you found what you are looking for?

- Need to detect harder X-rays?** Andor offers a range of Indirect Detection cameras (HH/HF range) which are compatible with industry-standard scintillators.
- Need a specific mounting?** Contact our experienced design team so we can make the perfect fit.
- Need a camera for VUV X-ray spectroscopy?** Andor's specialist spectrographic cameras (SO 920 or SO 940) are ideally suited for vacuum spectrographs.
- Need a customized version?** Please contact us to discuss our Customer Special Request options.

Product Drawings

Dimensions in mm [inches]

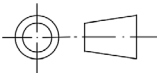

Third-angle projection

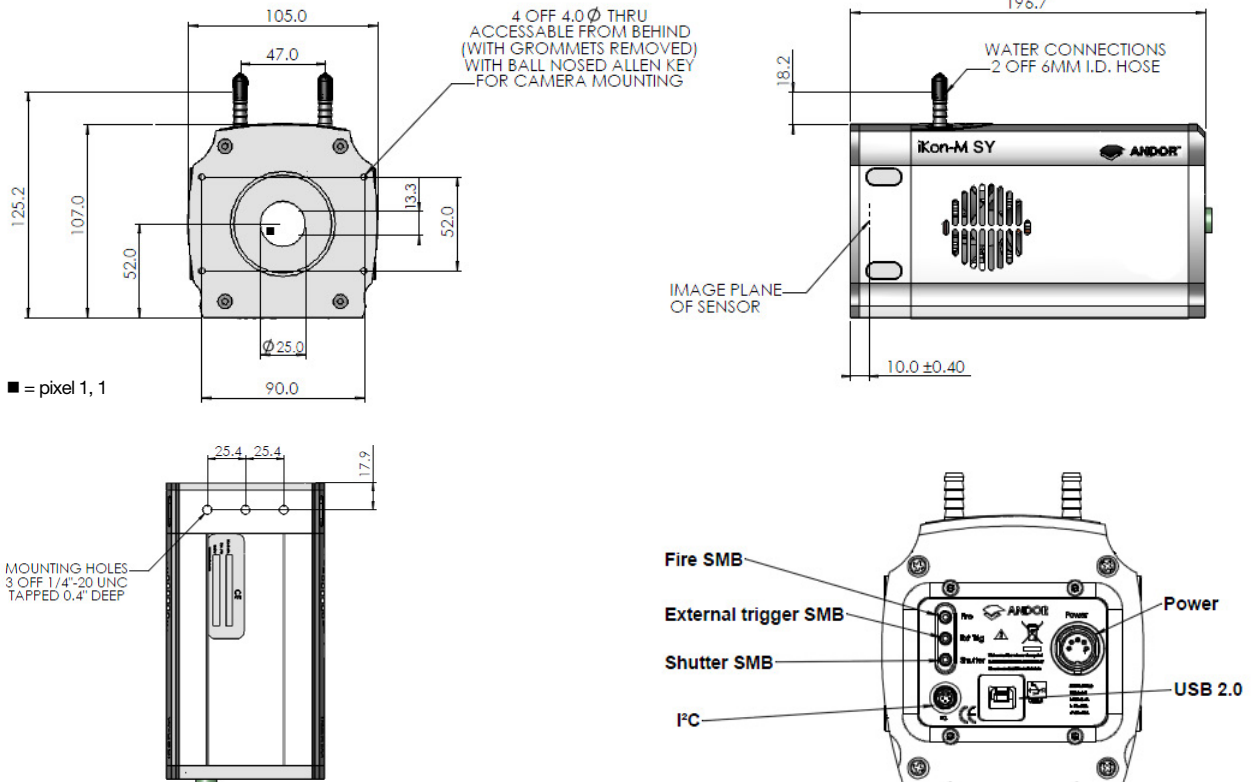

Weight: 2.2 kg [4 lb 13 oz]

Best Practice Guidelines

- ✓ When not in use the window should be covered and protected.
- ✗ Not suitable for mounting to vacuum chamber.
- ✓ Handle the camera with care - due to the exposed nature of the window, damage can easily occur through mishandling or by contamination.
- ✓ If due to accident or misuse the window becomes contaminated, please contact Andor immediately for advice on cleaning.
- ✗ Avoid shock damage as the Beryllium foil window is very brittle. If the foil is broken there is a health risk. Please contact Andor for further information if required.

Connecting to the iKon-M SY

Camera Control

Connector type: USB 2.0

TTL / Logic

Connector type: SMB, provided with SMB - BNC cable
Fire (Output), External Trigger (Input), Shutter (Output)

I²C connector

Compatible with Fischer SC102A054-130
Shutter (TTL), I²C Clock, I²C Data, +5 Vdc, Ground

Minimum cable clearance required at rear of camera
90 mm

Applications Guide

- ✓ X-ray Laser Development
- ✓ X-ray Plasma Diagnostics
- ✓ Soft X-ray Imaging
- ✓ X-ray Diffraction (XRD)
- ✓ X-ray Fluorescence (XRF)
- ✓ X-ray Spectroscopy
- ✓ Phase Contrast Imaging



Order Today

Need more information? At Andor we are committed to finding the correct solution for you. With a dedicated team of technical advisors, we are able to offer you one-to-one guidance and technical support on all Andor products. For a full listing of our regional sales offices, please see: www.andor.com/contact

Our regional headquarters are:

Europe

Belfast, Northern Ireland
Phone +44 (28) 9023 7126
Fax +44 (28) 9031 0792

Japan

Tokyo
Phone +81 (3) 6732 8968
Fax +81 (3) 6732 8939

North America

Concord, MA, USA
Phone +1 (860) 290 9211
Fax +1 (860) 290 9566

China

Beijing
Phone +86 (10) 5884 7900
Fax +86 (10) 5884 7901

Items shipped with your camera:

- 1 x 2 m SMB-BNC connection cable
- 1 x 3 m USB 2.0 cable Type A to Type B
- 1 x PS-25 power supply with mains cable
- 1 x CD containing Andor user guides
- 1 x Individual system performance booklet

Footnotes:

Specifications are subject to change without notice

1. **IMPORTANT:** Due to the Be window there is a limited warranty on the sensor. For full details of Andor's Warranty Policy please refer to our webpage at www.andor.com/contact_us/support_request/. For key information on handling precautions for SY/HY systems, please refer to the Best Practice Guidelines on page 5. Note permanent damage can easily occur due to misuse.
2. Edge pixels may exhibit a partial response.
3. Stabilized cooling temperatures are given for slowest readout speed. Use of faster readout speeds (in order to achieve faster frame rates) may require a higher cooling temperature to be selected. Specified minimum air cooled temperature assumes ambient temperature of 25°C. Specified minimum temperature with coolant assumes coolant temperature of 10°C.
4. Figures are typical unless otherwise stated.
5. Dark current measurement is averaged over the CCD area excluding any regions of blemishes.
6. Readout noise is for the entire system and is taken as a mean over the sensor area excluding any regions of blemishes. It is a combination of sensor readout noise and A/D noise.
7. Linearity is measured from a plot of counts vs exposure time under constant photon flux up to the saturation point of the system
8. The frame rates shown are for the BR-DD model, for a range of binning or array size combinations. All measurements are made with 4.25 µs vertical shift speed. It also assumes internal trigger mode of operation and minimum exposure time.
9. 5 MHz is for focusing/visualization mode only.
10. Quantum efficiency as provided by the sensor manufacturer.
11. The graph shows photoelectrons generated as a function of photon energy of incident X-ray.

Minimum Computer Requirements:

- 3.0 GHz single core or 2.4 GHz dual or quad core processor
- 2 GB RAM
- 100 MB free hard disc to install software (at least 1GB recommended for data spooling)
- USB 2.0 High Speed Host Controller capable of sustained rate of 40 MB/s
- Windows (8, 8.1 and 10) or Linux

Operating & Storage Conditions

- Operating Temperature 0°C to 30°C ambient
- Relative Humidity < 70% (non-condensing)
- Storage Temperature -25°C to 50°C

Power Requirements

- 100 - 240 VAC, 50 - 60 Hz
- Power consumption: 48W max.



Windows is a registered trademark of Microsoft Corporation.
Labview is a registered trademark of National Instruments.
Matlab is a registered trademark of The MathWorks Inc.