

# INTERFEROMETER VI-direct

Universal Interferometers for Quality Control

# INTERFEROMETER VI-direct Ideal for Production and Quality Control

Interferometers are an indispensable measurement tool for optical production and quality control. They are used for a wide variety of applications. Examples are testing of flatness and sphericity of optical surfaces, radius measurement and the testing of the wave-front of optical systems.

Features and benefits of the product line [Interferometer VI-direct](#):

- Working principle: Fizeau-Interferometer
- Cost effective alternative to conventional interferometers
- Digital camera with high lateral resolution (1600 x 1200 pixel)
- Direct connection to PC via USB port
- Quadruple digital zoom, no optical zoom required
- Test field diameter approx. 0.8 – 130 mm (depending on type)
- Usable in vertical, horizontal, or oblique directions. This makes the instrument extreme versatile for use in customer specific applications
- Choose between three different laser types according to the application (page 18)

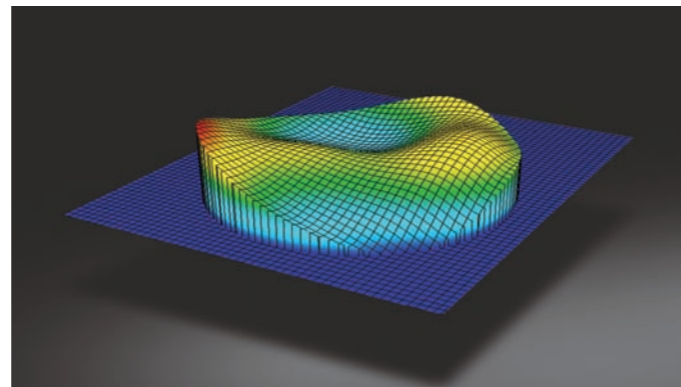

- Wide range of optical and mechanical accessories available
- Visual inspection as well as software based evaluation with [INTOMATIK-S](#) / [INTOMATIK-N](#)
- For visual or software based evaluation with [INTOMATIK-S](#) our Video-Mini-PC is well suited as smart solution (page 18)

Below the possible arrangements of the [Interferometer VI-direct](#) are shown schematically:

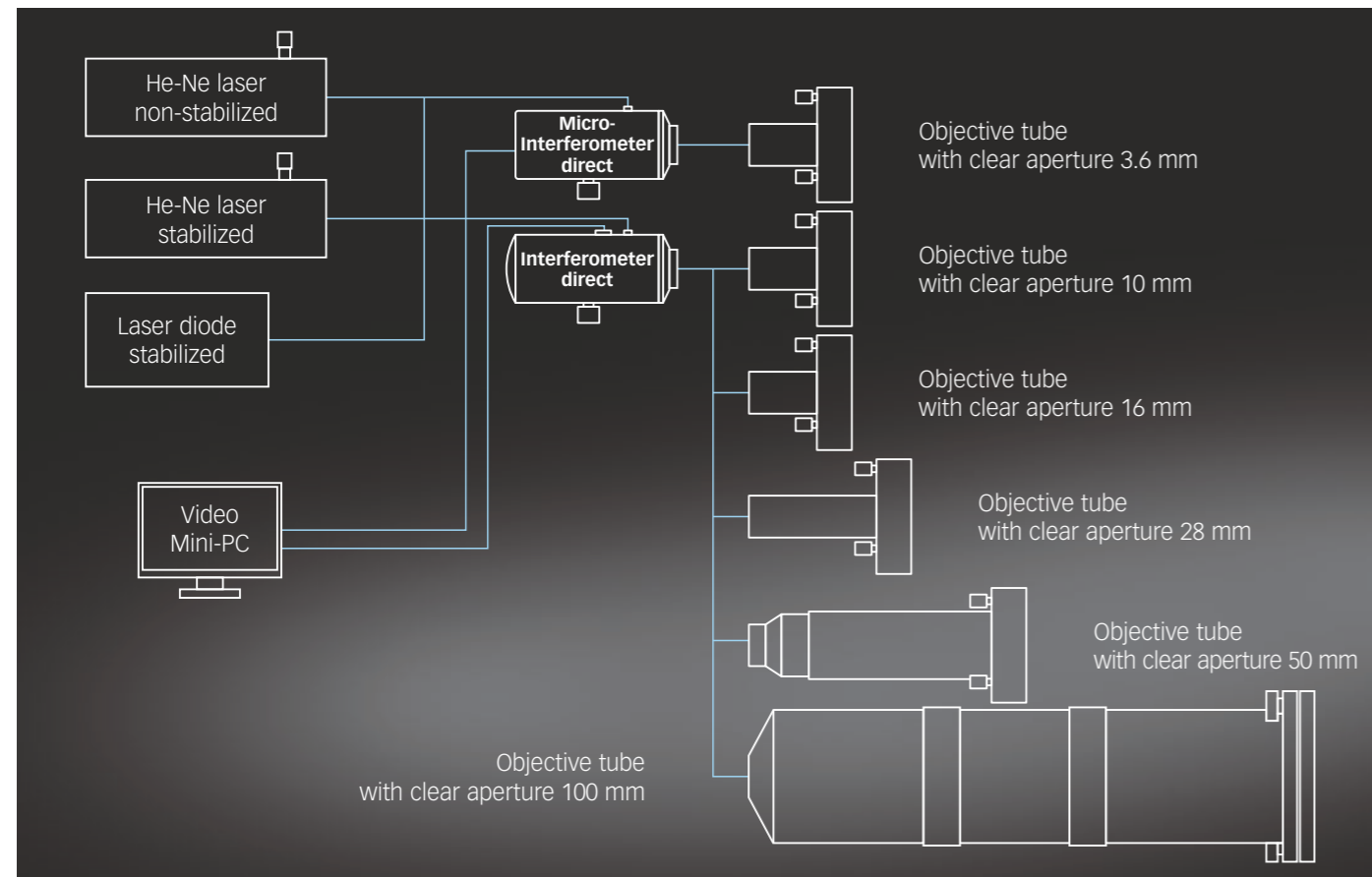

# INTERFEROMETER VI-direct Typical Applications

## Flatness Measurements of Surfaces

This setup is used for the measurement of surface flatness of plane elements such as mirrors, prisms and windows. For this set-up a transmission flat, a mount for the specimen (e.g. a self-centering holder) and a 2-axes adjustable mount are required.



## Wave-front and Wedge Angle Measurements of Plane Elements

This setup is used for the measurement of the wave-front deviation of plane elements and for wedge angle measurements. For this set-up two transmission flats, possibly a mount for the specimen (e.g. a self-centering holder) and one or two 2-axes adjustable mounts are required.

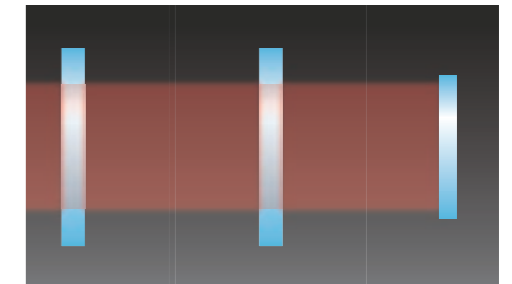

## Measurement of Sphericity of Lenses and Mechanical Parts

This setup allows the measurement of the deviation from sphericity of lenses and spherical mechanical parts. For this setup a transmission sphere, a mount for the specimen (e.g. a self-centering holder) and a 4-axes adjustable mount and a rail or radius measurement unit are required.

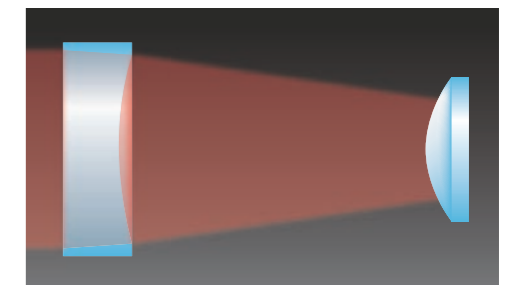

## Radius Measurement of Lenses and Mechanical Parts

This setup allows the measurement of the radius of curvature of lenses and spherical mechanical parts. For this setup a transmission sphere, a mount for the specimen (e.g. a self-centering holder) and a 4-axes adjustable mount and a radius measurement unit are required.

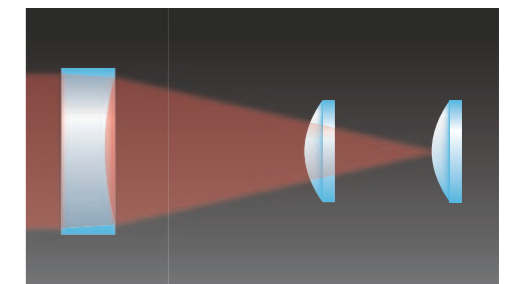

## Wave-front Measurement of Lenses and Imaging Systems

This setup is used for the measurement of the wave-front deviation of lenses and imaging systems. For this setup a transmission flat, a transmission sphere, a mount for the specimen (e.g. a self-centering holder), and two 4-axes adjustable mounts and a rail or radius measurement unit are required.

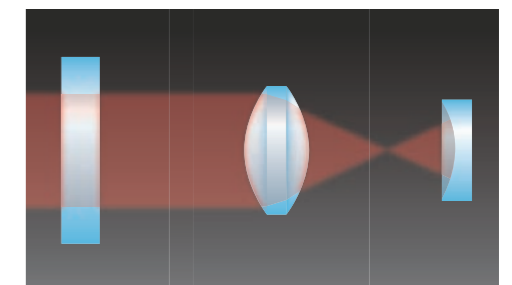

## Angle Measurement of 90°-Prisms and Corner Cubes

This setup allows the measurement of the angular error of 90°-prisms and triple mirrors. For this setup a transmission flat, a mount for the specimen (e.g. a self-centering holder) and a 2-axes adjustable mount or a tilting table are required.

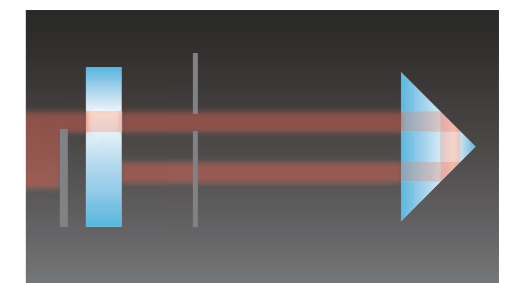

# MICRO-INTERFEROMETER VI-direct With Clear Aperture 3.6 mm

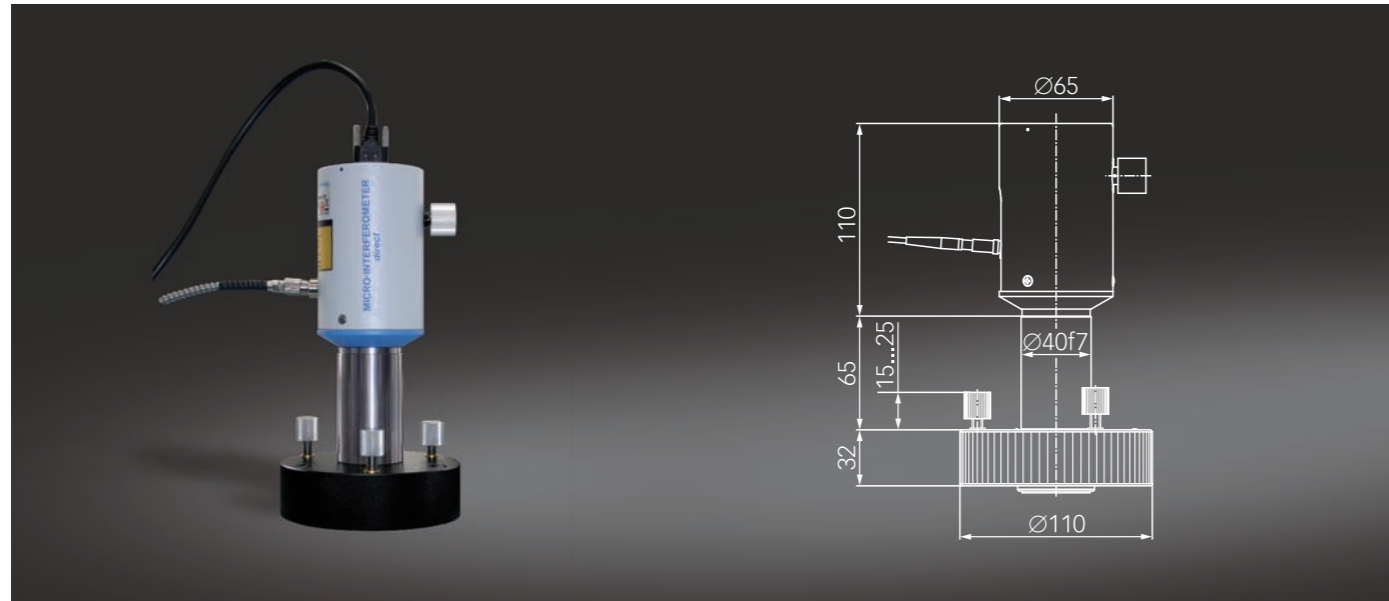

Description	Test Diameter	Laser	Art. No.
Micro-Interferometer VI-direct	0.8 - 3.6 mm	He-Ne laser (non-stabilized)	244 318
Micro-Interferometer VI-direct LD	0.8 - 3.6 mm	Laser diode (stabilized)	244 319

The **Micro-Interferometer VI-direct** extends the range of flatness testing to the domain of small diameters. The Fizeau-type interferometer is able to measure the surface flatness of optical parts like micro-prisms, laser crystals, fiber endings, etc. with diameters between 0.8 mm and 3.6 mm.

The user can configure the interferometer according to his measurement requirements with a non-stabilized fiber coupled He-Ne laser ( $\lambda=632.8$  nm) or with a stabilized laser diode ( $\lambda=635$  nm).

## Features and Benefits:

- Direct connection to PC/Laptop via USB 3.0 port, no frame grabber required
- Digital camera with high resolution (1600 x 1200 pixel)
- Insensitive to vibrations due to short exposure time (when using fringe evaluation software **INTOMATIK-S**)
- Usable in vertical, horizontal, or oblique directions
- Due to its compact design the **Micro-Interferometer VI-direct** is well suited for integration in application specific workstations
- Visual or optionally software supported evaluation with **INTOMATIK-S** or **INTOMATIK-N**
- Light source: fiber coupled He-Ne laser ( $\lambda=632.8$  nm) or stabilized laser diode ( $\lambda=635$  nm)
- Wide range of optical and mechanical accessories

## Typical Samples

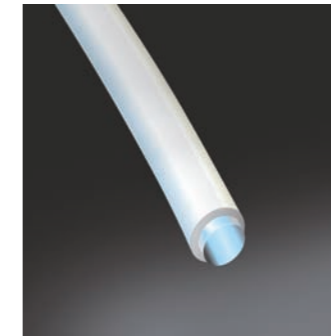

Fiber ends

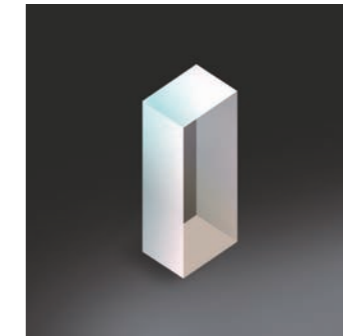

Crystals

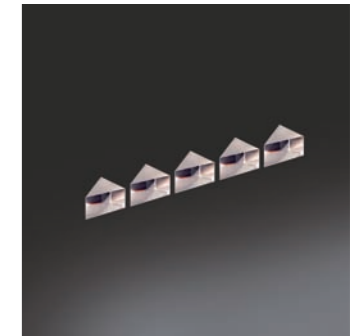

Micro prisms

## Optical Accessories



Description	Art. No.
Transmission flat D30; $\lambda/30$ p-v	244 352

## Mechanical Accessories

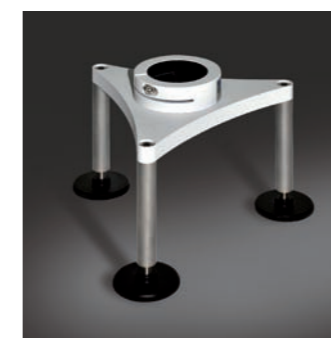

Description	Art. No.
Tripod D40	223 086

Description	Art. No.
Vertical stand D40 with tilting table	223 108
Vertical stand D40 with tilting table and phase shifting unit	223 165



# INTERFEROMETER VI-direct

## With Clear Aperture 10, 16 and 28 mm

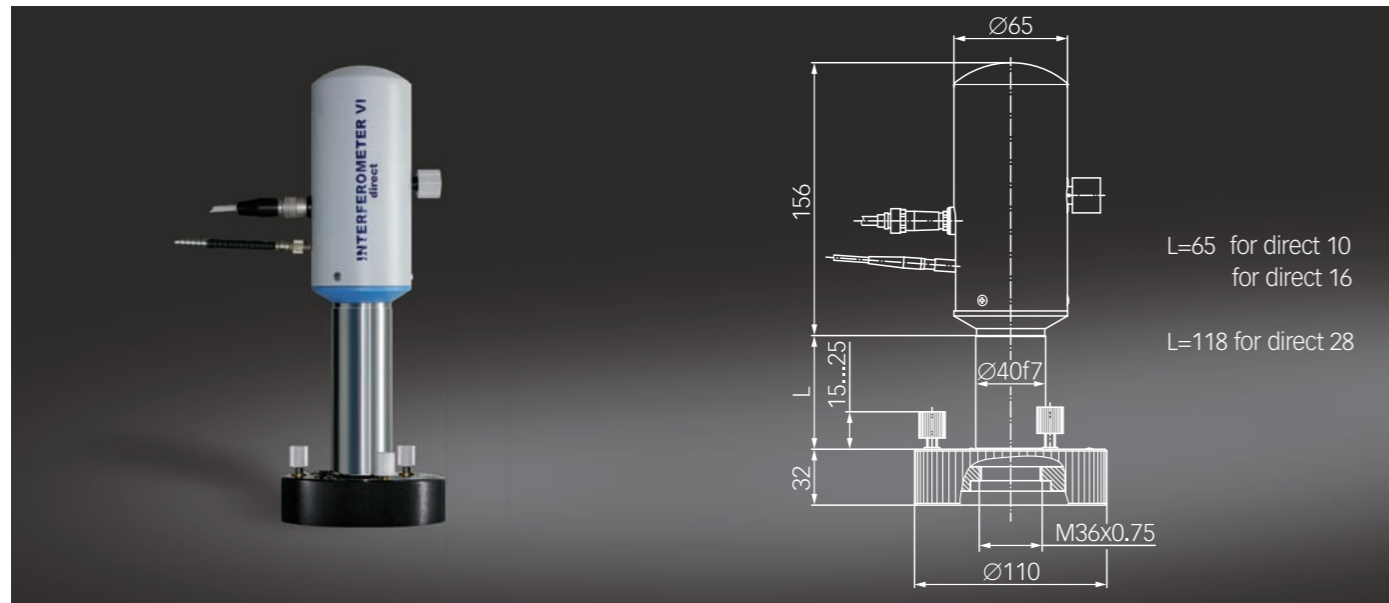

Description	Test diameter	Laser	Art. No.
Interferometer VI-direct 10	3 - 10 mm	He-Ne laser (non-stabilized)	244 306
Interferometer VI-direct SL 10	3 - 10 mm	He-Ne laser (stabilized)	244 301
Interferometer VI-direct LD 10	3 - 10 mm	Laser diode (stabilized)	244 334
Interferometer VI-direct 16	4 - 16 mm	He-Ne laser (non-stabilized)	244 307
Interferometer VI-direct SL 16	4 - 16 mm	He-Ne laser (stabilized)	244 302
Interferometer VI-direct LD 16	4 - 16 mm	Laser diode (stabilized)	244 335
Interferometer VI-direct 28	7 - 28 mm	He-Ne laser (non-stabilized)	244 308
Interferometer VI-direct SL 28	7 - 28 mm	He-Ne laser (stabilized)	244 303
Interferometer VI-direct LD 28	7 - 28 mm	Laser diode (stabilized)	244 336

The **Interferometers VI-direct** with clear aperture 10, 16 and 28 mm are able to measure flats with a diameter of 3 to 28 mm and spheres of varying diameter depending on selected transmission sphere.

The user can configure the interferometer according to his measurement requirements with a fiber coupled He-Ne laser ( $\lambda=632.8$  nm, stabilized or non-stabilized) or with a stabilized laser diode ( $\lambda=635$  nm).

### Features and Benefits:

- Direct connection to PC/Laptop via USB port, no frame grabber required
- Digital camera with high resolution (1600 x 1200 pixel)
- Insensitive to vibrations due to short exposure time (when using fringe evaluation software **INTOMATIK-S**)
- Usable in vertical, horizontal, or oblique directions
- Due to its compact design the **Interferometer VI-direct** is well suited for integration in application specific workstations
- Visual or optionally software supported evaluation with **INTOMATIK-S** or **INTOMATIK-N**
- Light source: fiber coupled non-stabilized He-Ne laser ( $\lambda=632.8$  nm) or stabilized He-Ne laser ( $\lambda=632.8$  nm) or stabilized laser diode ( $\lambda=635$  nm).
- Wide range of optical and mechanical accessories

### Optical Accessories

Description	Art. No.
Transmission flat D16; $\lambda/30$ p-v	244 350
Transmission flat D28; $\lambda/30$ p-v	244 351



Description	Art. No.
Transmission-sphere R20	244 381
-sphere R35	244 382
-sphere R54	244 383
-sphere R87	244 384
-sphere R175	244 385



### Info:

An overview of suitable transmission spheres can be found on page 12. Transmission spheres with other radii are available on request. The interferometers can also be operated with transmission spheres and flats of other manufacturers, e.g. by using the following adapter (other adapters on request).

Description	Art. No.
Adapter M36 x 0.75 on bayonet D70	244 357



### Mechanical Accessories

Description	Art. No.
Height adjustable vertical stand D40 with tilting table	223 151
Height adjustable vertical stand D40 with XY- and tilting table	223 155
Height adjustable vertical stand D40 with XY-, tilting table and phase shifting unit	223 159



Description	Art. No.
Vertical stand D40 with tilting table	223 108
Vertical stand D40 with tilting table and phase shifting unit	223 165



Description	Art. No.
Tripod D40	223 086



# INTERFEROMETER VI-direct With Clear Aperture 50 mm

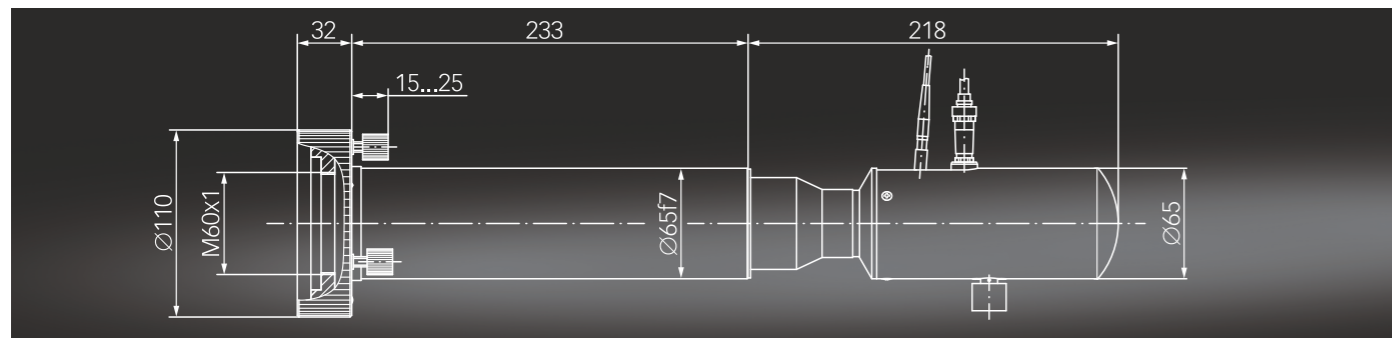
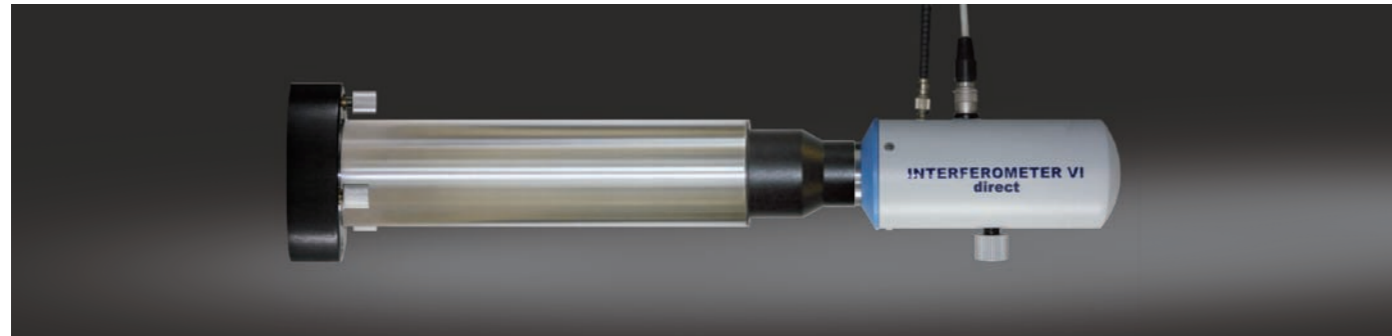

Description	Test Diameter	Laser	Art. No.
Interferometer VI-direct 50	12 - 50 mm	He-Ne laser (non-stabilized)	244 309
Interferometer VI-direct SL 50	12 - 50 mm	He-Ne laser (stabilized)	244 304
Interferometer VI-direct LD 50	12 - 50 mm	Laser diode (stabilized)	244 337

The **Interferometer VI-direct** with clear aperture 50 mm is able to measure flats with a diameter of 12 to 50 mm and spheres with diameter depending on selected transmission sphere.

The user can configure the interferometer according to his measurement requirements with a fiber coupled He-Ne laser ( $\lambda=632.8$  nm, stabilized or non-stabilized) or with a stabilized laser diode ( $\lambda=635$  nm).

## Features and Benefits:

- Direct connection to PC/Laptop via USB port, no frame grabber required
- Digital camera with high resolution (1600 x 1200 pixel)
- Insensitive to vibrations due to short exposure time (when using fringe evaluation software **INTOMATIK-S**)
- Usable in vertical, horizontal, or oblique directions
- Due to its compact design the **Interferometer VI-direct** is well suitable for integration in application specific workstations
- Visual or optionally software supported evaluation with **INTOMATIK-S** or **INTOMATIK-N**
- Light source: fiber coupled non-stabilized He-Ne laser ( $\lambda=632.8$  nm) or stabilized He-Ne laser ( $\lambda=632.8$  nm) or stabilized laser diode ( $\lambda=635$  nm)
- Wide range of optical and mechanical accessories

## Optical Accessories

Description	Art. No.
Transmission flat D50; $\lambda/30$ p-v	244 353



Description	Art. No.
Transmission-sphere R40	244 365
-sphere R80	244 369
-sphere R120	244 377
-sphere R300	244 373



## Info:

An overview of suitable transmission spheres can be found on page 12. Transmission spheres with other radii are available on request. The interferometers can also be operated with transmission spheres and flats of other manufacturers, e.g. by using the following adapter (other adapters on request).

Description	Art. No.
Adapter M60 x 1.0 on bayonet D70	244 358

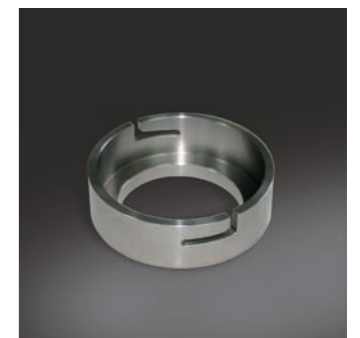

## Mechanical Accessories

Description	Art. No.
Height adjustable vertical stand D65 with tilting table	223 153
Height adjustable vertical stand D65 with XY- and tilting table	223 157
Height adjustable vertical stand D65 with XY-, tilting table and phase shifting unit	223 161



Description	Art. No.
Vertical stand D65 with tilting table	223 107
Vertical stand D65 with tilting table and phase shifting unit	223 167



Description	Art. No.
Tripod D65	223 089



# INTERFEROMETER VI-direct With Clear Aperture 100 mm

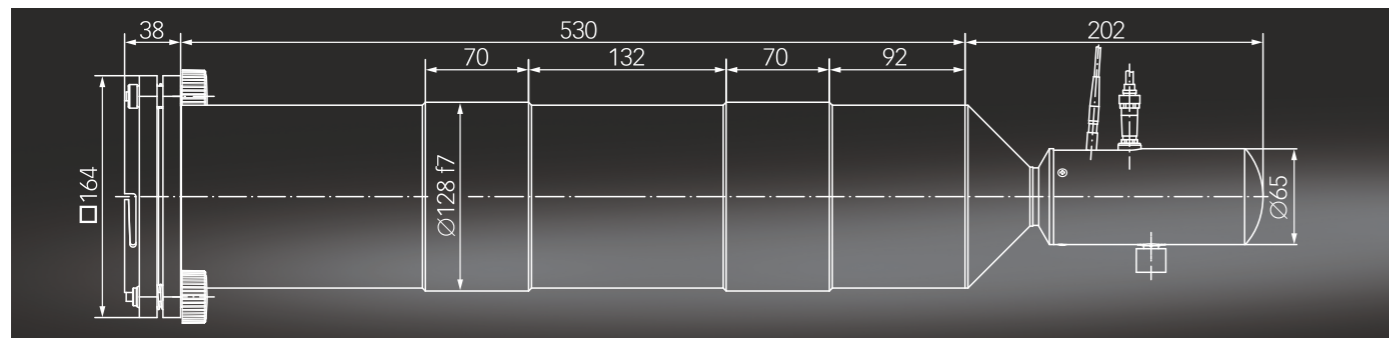
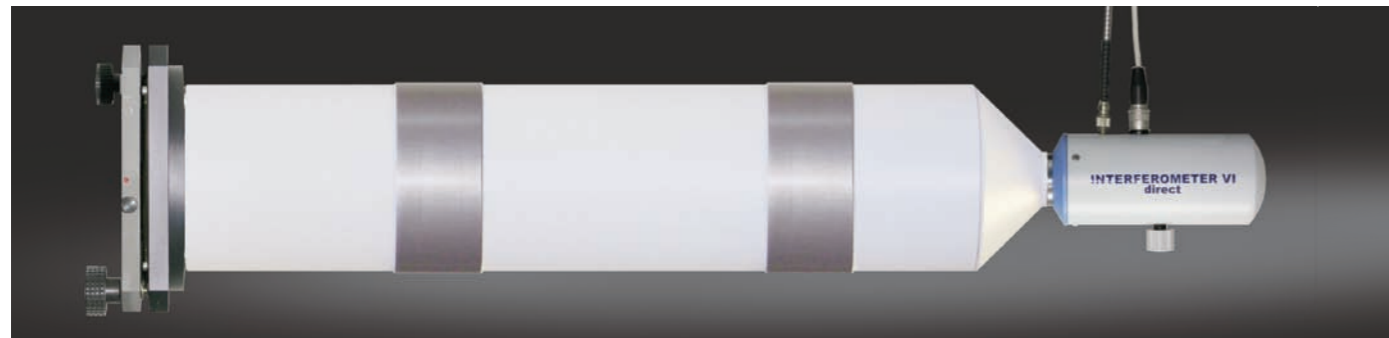

Description	Test Diameter	Laser	Art.-Nr.
Interferometer VI-direct 100	25 - 100 mm	He-Ne laser (non-stabilized)	244 310
Interferometer VI-direct SL 100	25 - 100 mm	He-Ne laser (stabilized)	244 305
Interferometer VI-direct LD 100	25 - 100 mm	Laser diode (stabilized)	244 338

The *Interferometer VI-direct* with clear aperture 100 mm is able to measure flats with a diameter of 25 to 100 mm and spheres with diameter depending on selected transmission sphere.

The user can configure the interferometer according to his measurement requirements with a fiber coupled He-Ne laser ( $\lambda=632.8$  nm, stabilized or non-stabilized) or with a stabilized laser diode ( $\lambda=635$  nm).

## Features and Benefits:

- Direct connection to PC/Laptop via USB port, no frame grabber required
- Digital camera with high resolution (1600 x 1200 pixel)
- Insensitive to vibrations due to short exposure time (when using fringe evaluation software *INTOMATIK-S*)
- Usable in vertical, horizontal, or oblique directions
- Due to its compact design the *Interferometer VI-direct* is well suitable for integration in application specific workstations
- Visual or optionally software supported evaluation with *INTOMATIK-S* or *INTOMATIK-N*
- Light source: fiber coupled non-stabilized He-Ne laser ( $\lambda=632.8$  nm) or stabilized He-Ne laser ( $\lambda=632.8$  nm) or stabilized laser diode ( $\lambda=635$  nm)
- Wide range of optical and mechanical accessories
- The bayonet connection of the interferometer is compatible to the standard Zygo® 4" connection

## Optical Accessories

Description	Art. No.
Transmission flat D100; $\lambda/20$ p-v	244 475



### Info:

By the combination of an optical connector with a transmission sphere, the innovative transmission sphere system allows a considerably increased measurement range and a 60% superior illumination compared to classical transmission spheres. One optical connector is needed. It can be combined with all transmission spheres. The principle and a selection guide are shown on page 13. The use of transmission spheres of other manufacturers is possible, too.

Description	Art. No.
Attenuator D100	244 237
Attenuator D150	244 238
Base 84 for attenuator	244 259

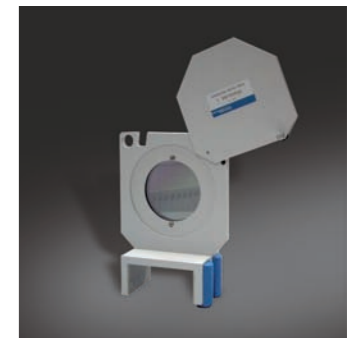

Description	Art. No.
Transmission-sphere R49*	244 761
-sphere R64*	244 762
-sphere R102*	244 763
-sphere R167*	244 764
-sphere R291*	244 765
-sphere R516*	244 766
-sphere R805*	244 767
-sphere R1164*	244 768
-flat D130*	244 770
Optical connector	244 760

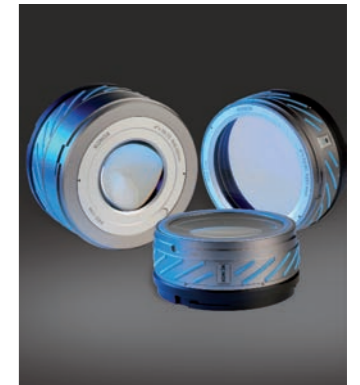

\*Note: Additionally, an optical connector is needed!

## Mechanical Accessories

Description	Art. No.
Vertical stand D128 with tilting table	223 110
Vertical stand D128 with XY- and tilting table	223 171
Vertical Stand D128 with XY-, tilting table and phase shifting unit	223 173

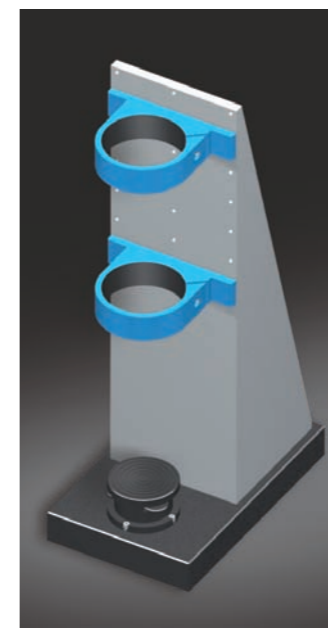

Description	Art. No.
Fixture D128	223 112



Description	Art. No.
Adjustable holder D128	223 058

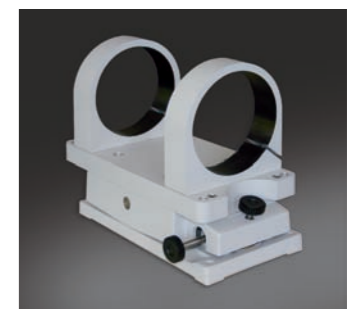

Description	Art. No.
Radius measurement unit 400 mm	244 285
Radius measurement unit 600 mm	244 286
Radius measurement unit 1000 mm	244 236
Radius measurement unit 1400 mm	244 287

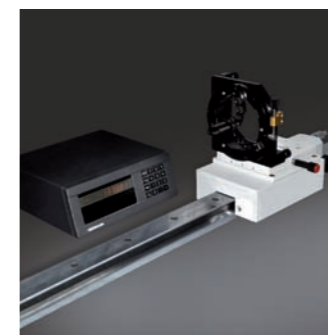

Description	Art. No.
4-axes adjustable mount	244 243
2-axes adjustable mount	244 246



# INTERFEROMETER VI-direct

## Choice of Transmission Sphere

For testing of spherical surfaces so called transmissions spheres are used. These generate a reference wave which can be tested against a spherical sample interferometrically. Transmission spheres are available with different radii ( $R_{(Fizeau)}$ ) and usable diameters ( $D_{(Fizeau)}$ ). To measure the whole spherical surface under test the following condition must be fulfilled:

$$R/D_{(Fizeau)} \leq R/D_{(surface\ under\ test)}$$

For the best choice of transmission spheres for respective measuring tasks the following graphics and tables can be used.

### Transmission Sphere For Interferometer VI-direct 10, 16, 28

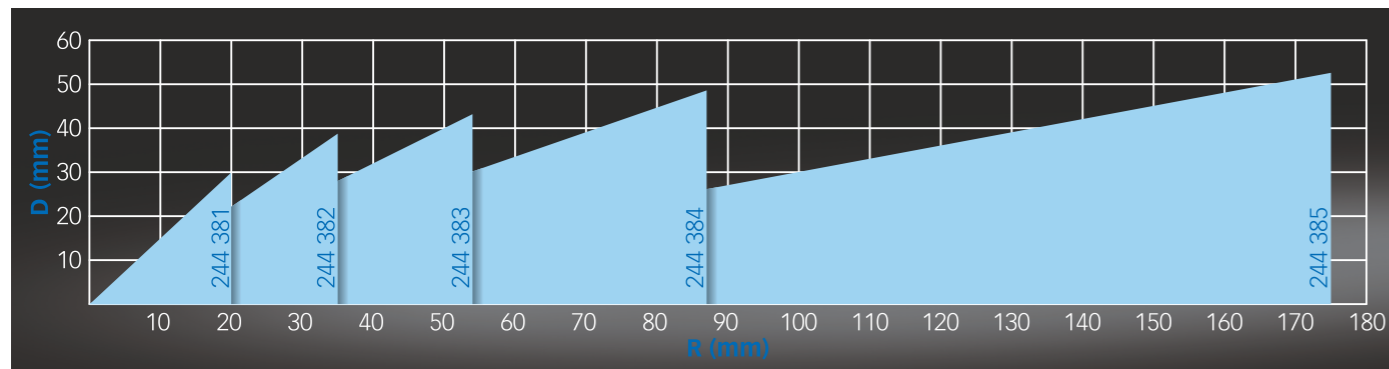

Description	F-Number	R (Fizeau)	D (Fizeau)	Art. No.
Transmission sphere R20	0.67	20 mm	30 mm	<b>244 381</b>
Transmission sphere R35	0.91	35 mm	39 mm	<b>244 382</b>
Transmission sphere R54	1.25	54 mm	43 mm	<b>244 383</b>
Transmission sphere R87	1.79	87 mm	49 mm	<b>244 384</b>
Transmission sphere R175	3.33	175 mm	52 mm	<b>244 385</b>

### Transmission Sphere For Interferometer VI-direct 50

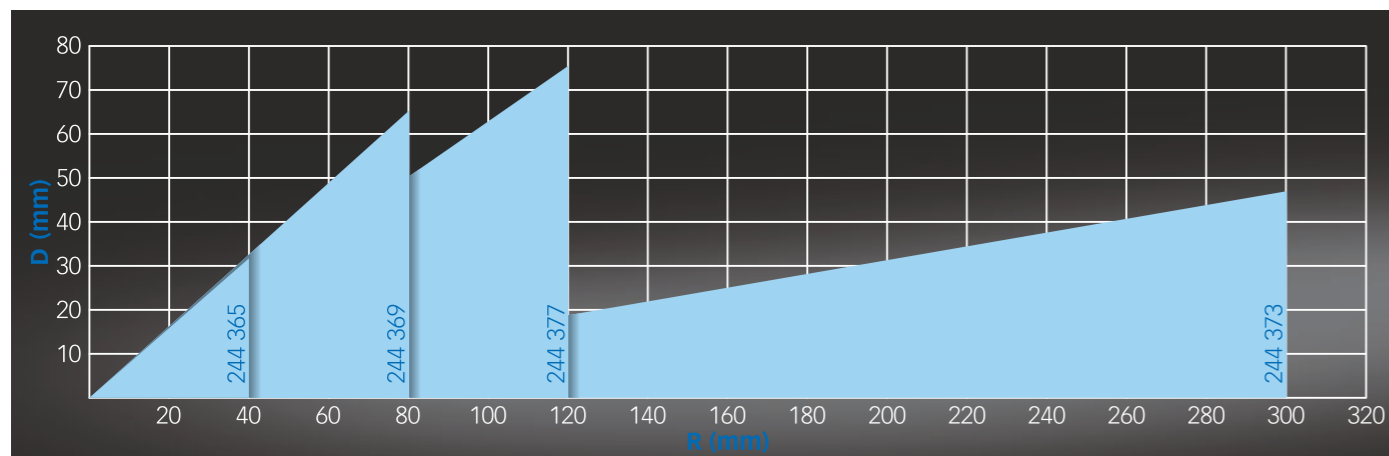

Description	F-Number	R (Fizeau)	D (Fizeau)	Art. No.
Transmission sphere R40	1.25	40 mm	32 mm	<b>244 365</b>
Transmission sphere R80	1.25	80 mm	64 mm	<b>244 369</b>
Transmission sphere R120	1.60	120 mm	75 mm	<b>244 377</b>
Transmission sphere R300	6.38	300 mm	47 mm	<b>244 373</b>

### Transmission Sphere For Interferometer VI-direct 100

The transmission sphere system consists of an optical connector, which includes parts of the lens system and a transmission sphere. Therefore the transmission sphere can be reduced to a minimal number of optical components. The arrangement of connector and transmission sphere results in a larger aperture diameter and in a larger measurement range in comparison to standard 4" transmission spheres.

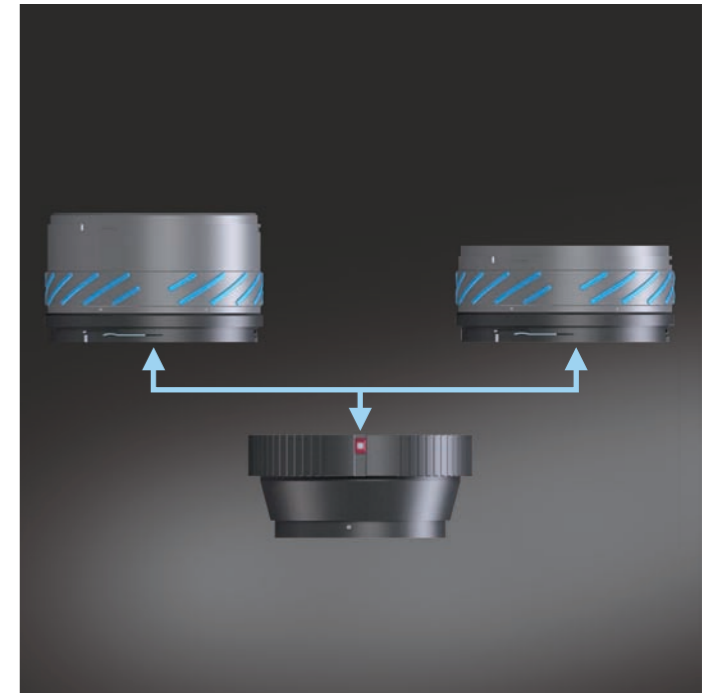

Description	Art. No.
Optical connector	<b>244 760</b>

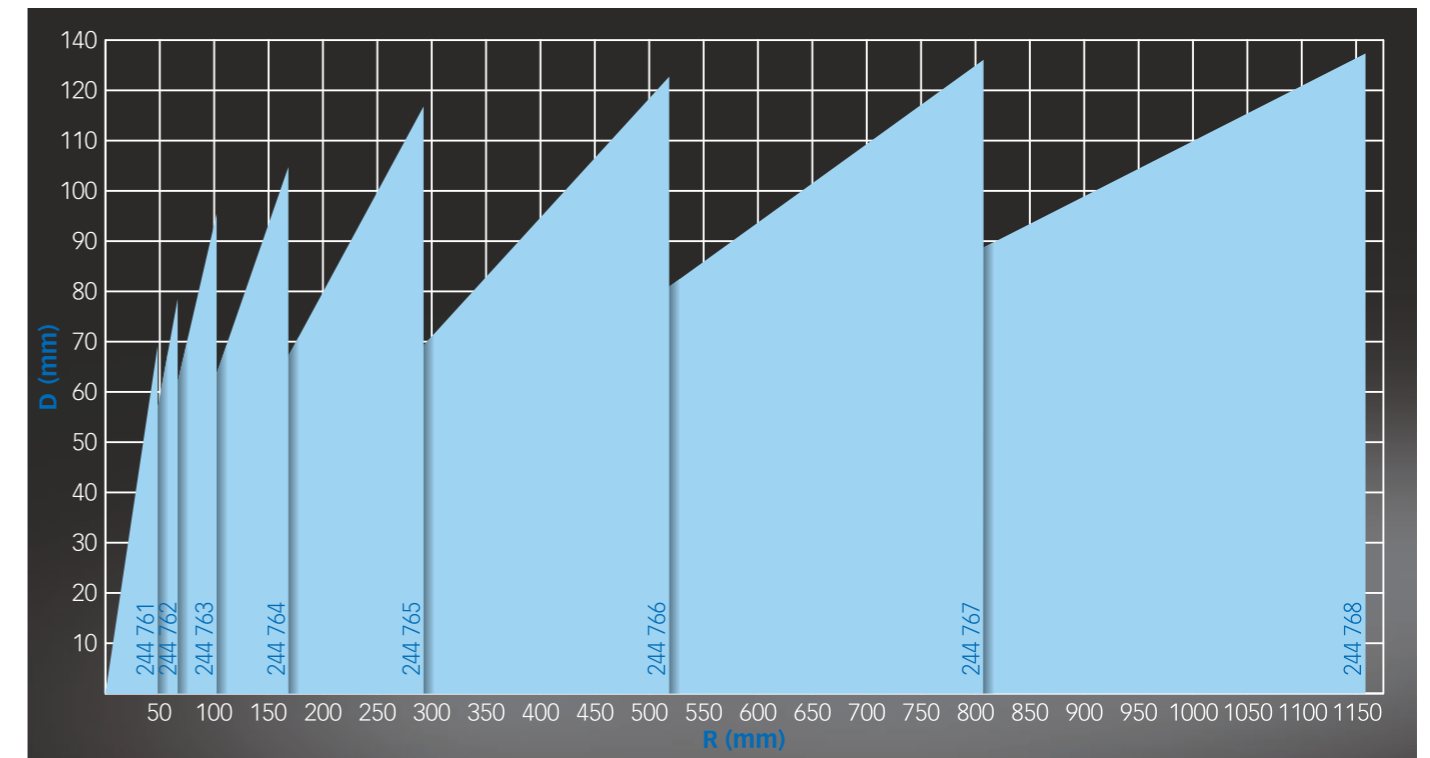

Description	F-Number	R (Fizeau)	D (Fizeau)	Art. No.
Transmission sphere R49*	0.7	49 mm	70 mm	<b>244 761</b>
Transmission sphere R64*	0.8	64 mm	77 mm	<b>244 762</b>
Transmission sphere R102*	1.1	102 mm	95 mm	<b>244 763</b>
Transmission sphere R167*	1.6	167 mm	107 mm	<b>244 764</b>
Transmission sphere R291*	2.5	291 mm	118 mm	<b>244 765</b>
Transmission sphere R516*	4.2	516 mm	123 mm	<b>244 766</b>
Transmission sphere R805*	6.4	805 mm	126 mm	<b>244 767</b>
Transmission sphere R1164*	9.2	1164 mm	128 mm	<b>244 768</b>

\*Note: For these transmission spheres an optical connector is needed!

## INTERFEROMETER VI-direct Application Examples

### Application Areas:

Due to their compact design the interferometers are excellently suited for the setup of application-specific work stations. The pictures below show some application examples for the interferometers of the VI-series.

Measuring station for testing of plane surfaces with diameter up to 100 mm in incident light.

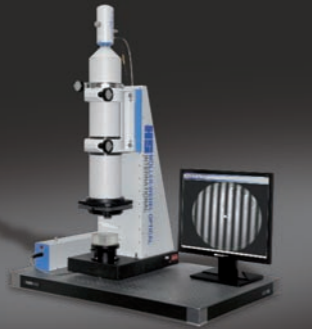
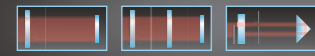

Measuring station for testing of plane surfaces in incident light with phase shifting unit.

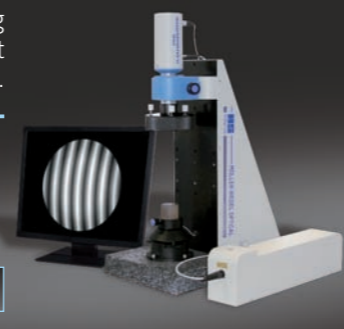

Measuring station for determination of radii, testing of plane and spherical surfaces in incident light.

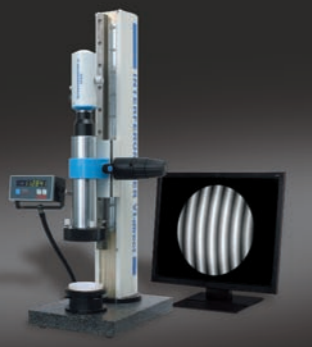

Measuring station for testing of prism surfaces.



Micro-Interferometer VI direct for testing of plane optics with test diameter between 0.8 mm and 3.6 mm.

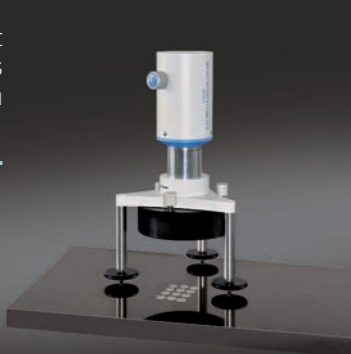
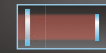

Measuring station for fast testing of plane optical components.

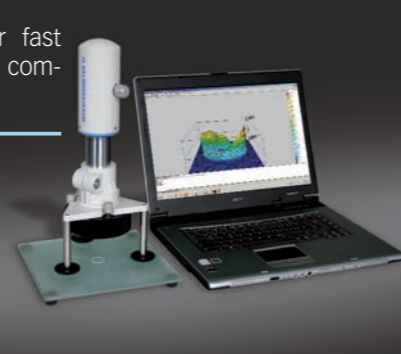
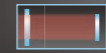

Measuring station for testing of plane and spherical surfaces, determination of radii and wave-front deformations.

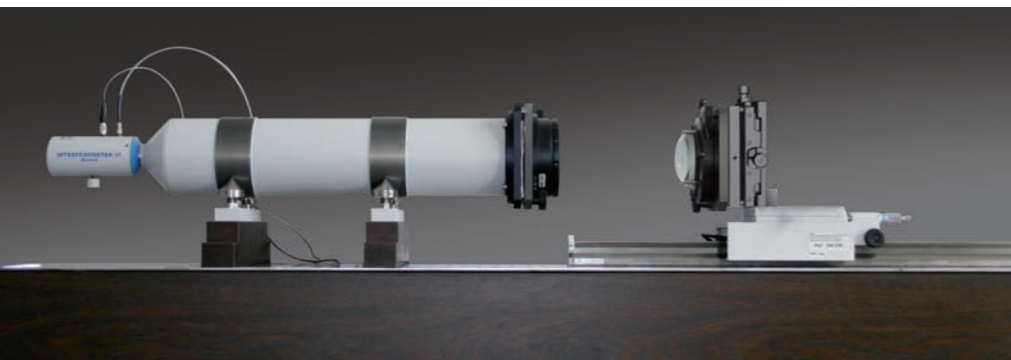

## INTERFEROMETER VI-direct 50 PUL Measuring Station for Testing of Plane Surfaces

### Application

The plane surface Interferometer VI-direct 50 PUL allows the fast testing of flatness of uncoated and mirror-coated plane surfaces with test diameter between 12 mm and 50 mm. Due to the special design the interferogram can be directly evaluated after placement of the sample without any readjustment. Optionally a software-based evaluation is also possible.

### Hardware

Following components are included:

- Interferometer VI-direct 50
- Sample support with tilting function
- Set of aperture stops
- Fiber coupled Laser
- Video-Mini-PC

### Description

Interferometer VI-direct 50 PUL

### Art. No.

244 915

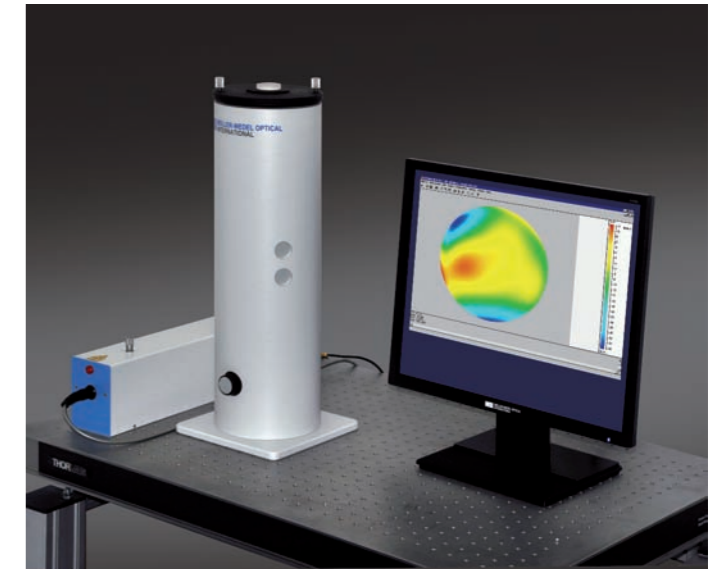

## INTERFEROMETER VI-direct 28 SUL Measuring Station for Testing of Spherical Surfaces

### Application

The measuring station Interferometer VI-direct 28 SUL enables the fast testing of form or radii deviation of spherical surfaces. Optionally a software-based evaluation is also possible.

### Hardware

Following components are included:

- Interferometer VI-direct 28
- Sample support with XY-translation
- Set of aperture stops
- Fiber coupled stabilized laser
- Display unit for radii measurement
- Vibration-damped table
- Video-Mini-PC

### Description

Interferometer VI-direct 28 SUL

### Art. No.

244 930

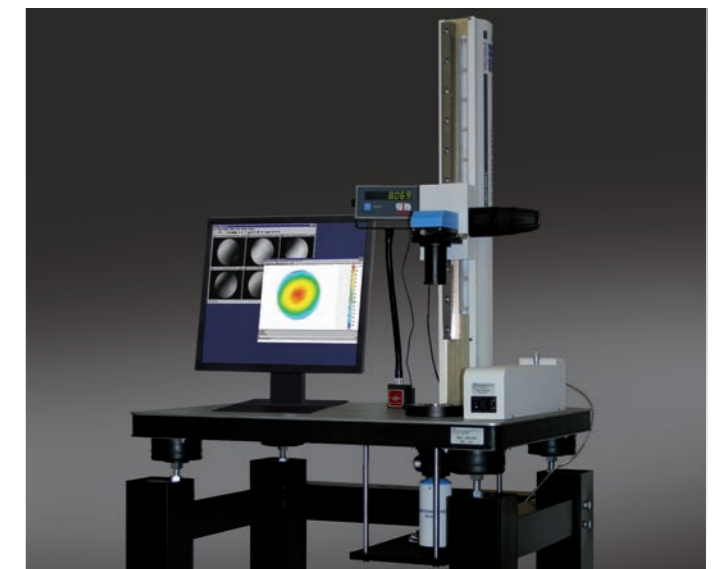



# INTOMATIK-S Software for Fringe Processing

## Overview

- Evaluation of single interferograms with open fringes according to the ISO 10110-5 standard
- No phase shifting unit required
- Unlike phase shifting evaluation, the determination of the sign of the surface form deviation is not possible
- Operating system Windows® 7/10
- Integrated digital zoom
- Large measuring range by use of the full camera resolution
- Coordinate representation in pixel, mm or inches
- Automatic protocol generation
- Export results in \*.opd-format or as raw data for further processing

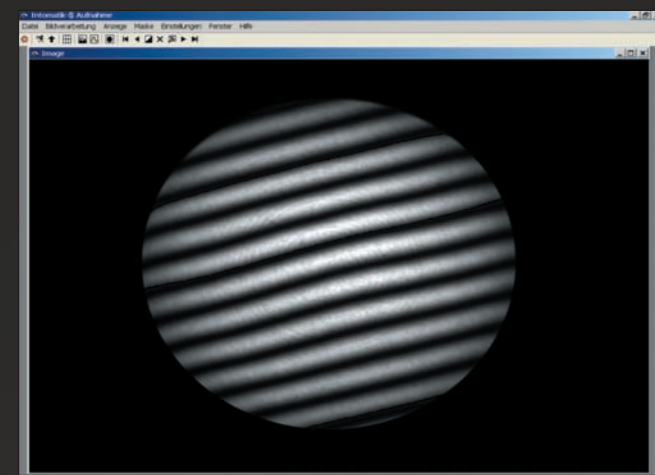
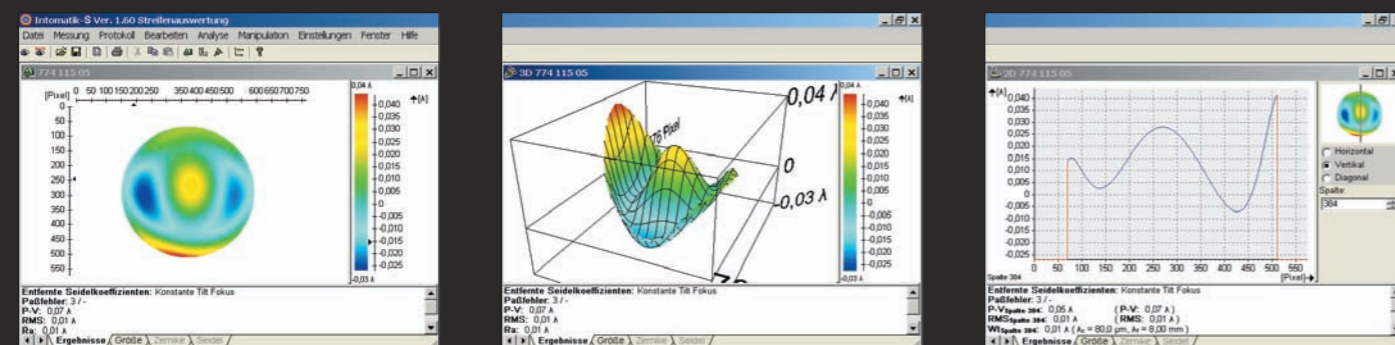

## Recording Module

- Permanent live-interferogram display, colored overmodulation display in live-image
- Extensive masking options
- Histogram function
- Saving of intensity distribution as \*.bmp-file

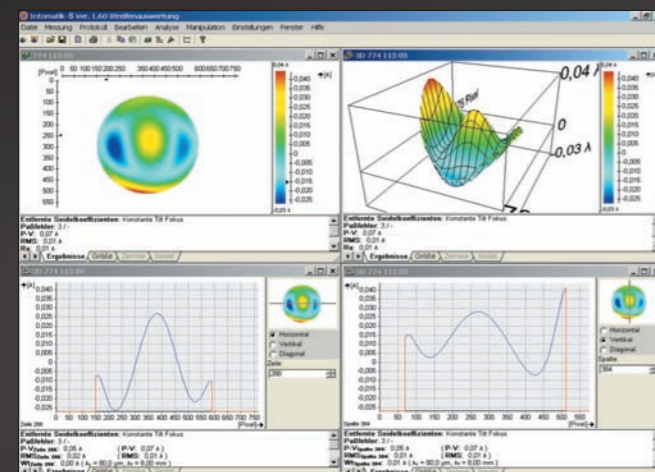

## Evaluation Module

- Display results as contour, 3D- and 2D-plot
- Extensive manipulation options like averaging, filtering and fitting of the phase distribution

# INTOMATIK-N Software for Evaluation

## Overview

- Evaluation of phase shifted interferograms according to ISO 10110-5 standard
- Operating system Windows® 7/10
- Integrated digital zoom
- Large measuring range by use of the full camera resolution
- Coordinate representation in pixel, mm or inches
- Manual and automatic calibration of the phase shifting unit
- Automatic protocol generation
- Export results in \*.opd-format or as raw data for further processing

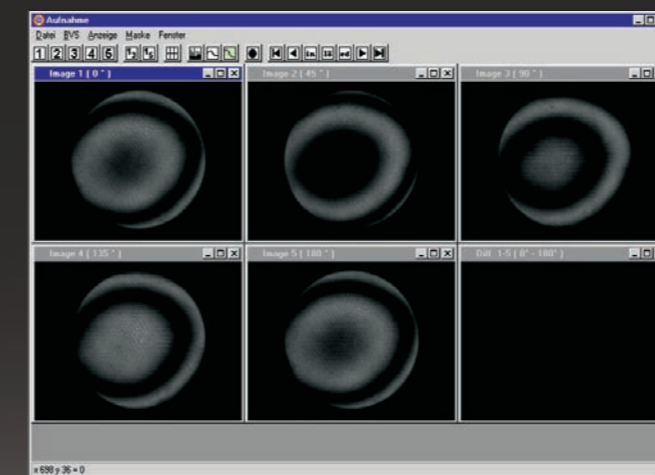
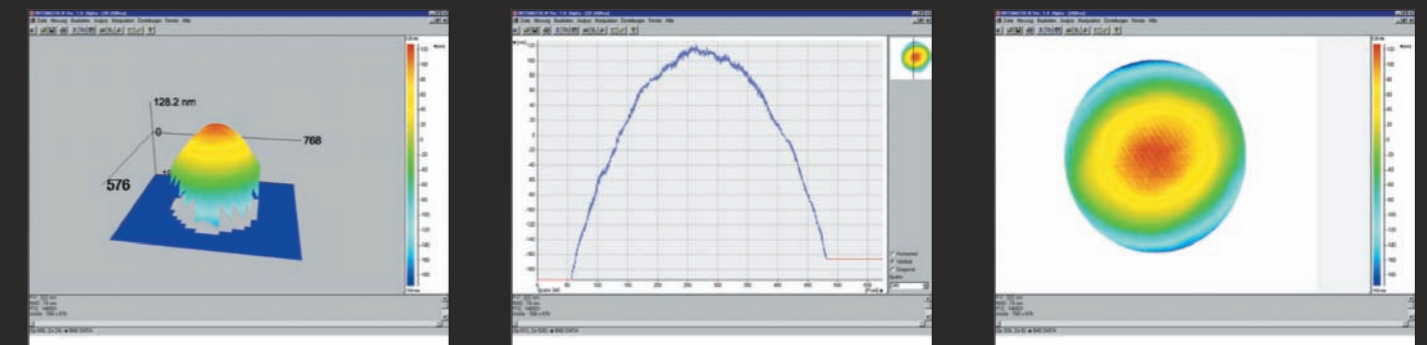

## Recording Module

- Permanent live-interferogram display, colored overmodulation display in live-image
- Extensive masking options
- Histogram function
- Saving of intensity distribution as \*.bmp-file

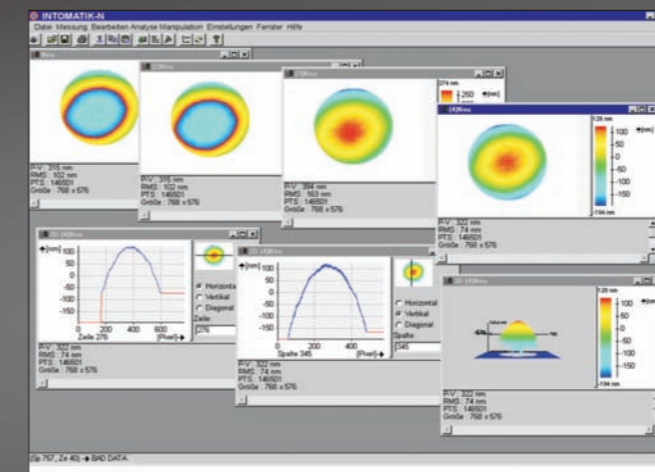

## Evaluation Module

- Display of the results as contour, 3D- and 2D-plot
- Extensive manipulation options like averaging, filtering, and fitting of the phase distribution
- In addition to the measurement of flat and spherical surfaces, measurements of 90°-prisms, corner cubes and homogeneity as well as absolute testing and three flat test are also included

## INTERFEROMETER VI-direct General Accessories

### Laser

The Interferometer VI-direct series is offered in three versions. These differ by the laser included in the scope of delivery.

The He-Ne laser is a typical gas laser with CW-mode. It emits in the visible range at 632.8 nm wavelength and is very common in scientific applications. One further benefit is its relative simple set-up. This guarantees a high reliability and easy handling of the laser. You can choose between a non-stabilized and a frequency-stabilized version. The frequency-stabilized laser diode, which emits at 635 nm  $\pm$  2 nm, offers a space-saving solution.



Description	Art. No.
He-Ne laser (632.8 nm)	244 330
Frequency stabilized He-Ne laser (632.8 nm)	244 332
Frequency stabilized laser diode (635.0 nm)	244 333

All lasers are fiber-coupled and interchangeable among each other.

### Video-Mini-PC (optional)

The Video-Mini-PC is based on a full-fledged mini-PC (Windows® 10) with a 19" monitor and can be used as a space-saving solution for visual evaluation or with INTOMATIK-S.

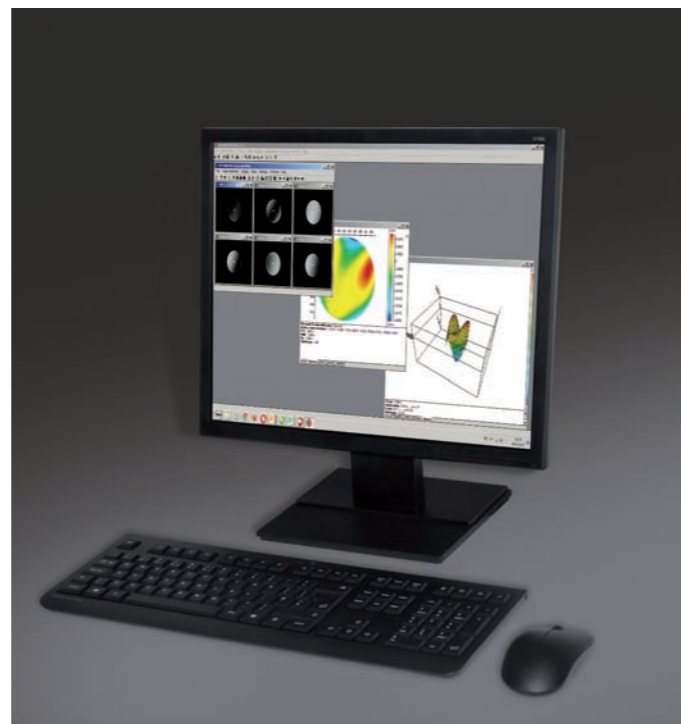

Description	Art. No.
Video-Mini-PC	229 933

## INTERFEROMETER VI-direct Technical Data

Interferometer	Test Diameter mm	Laser	Dimension* in mm	Weight* kg	Art. No.
<b>Micro VI-direct</b>	0.8-3.6	He-Ne laser (non-stabilized)	Ø110x210	1.4	<b>244 318</b>
<b>Micro VI-direct LD</b>	0.8-3.6	Laser diode (stabilized)	Ø110x210	1.4	<b>244 319</b>
<b>VI-direct 10</b>	3-10	He-Ne laser (non-stabilized)	Ø110x254	1.5	<b>244 306</b>
<b>VI-direct SL 10</b>	3-10	He-Ne laser (stabilized)	Ø110x254	1.5	<b>244 301</b>
<b>VI-direct LD 10</b>	3-10	Laser diode (stabilized)	Ø110x254	1.5	<b>244 334</b>
<b>VI-direct 16</b>	4-16	He-Ne laser (non-stabilized)	Ø110x254	1.5	<b>244 307</b>
<b>VI-direct SL 16</b>	4-16	He-Ne laser (stabilized)	Ø110x254	1.5	<b>244 302</b>
<b>VI-direct LD 16</b>	4-16	Laser diode (stabilized)	Ø110x254	1.5	<b>244 335</b>
<b>VI-direct 28</b>	7-28	He-Ne laser (non-stabilized)	Ø110x306	1.7	<b>244 308</b>
<b>VI-direct SL 28</b>	7-28	He-Ne laser (stabilized)	Ø110x306	1.7	<b>244 303</b>
<b>VI-direct LD 28</b>	7-28	Laser diode (stabilized)	Ø110x306	1.7	<b>244 336</b>
<b>VI-direct 50</b>	12-50	He-Ne laser (non-stabilized)	Ø110x484	3.0	<b>244 309</b>
<b>VI-direct SL 50</b>	12-50	He-Ne laser (stabilized)	Ø110x484	3.0	<b>244 304</b>
<b>VI-direct LD 50</b>	12-50	Laser diode (stabilized)	Ø110x484	3.0	<b>244 337</b>
<b>VI-direct 100</b>	25-100	He-Ne laser (non-stabilized)	□164x770	9.7	<b>244 310</b>
<b>VI-direct SL 100</b>	25-100	He-Ne laser (stabilized)	□164x770	9.7	<b>244 305</b>
<b>VI-direct LD 100</b>	25-100	Laser diode (stabilized)	□164x770	9.7	<b>244 338</b>

Measuring Accuracy	Visual evaluation	$\lambda/10$ p-v	Evaluation with software	$\lambda/20$ p-v
--------------------	-------------------	------------------	--------------------------	------------------

\*Note: Dimension and weight without laser!

**MÖLLER-WEDEL OPTICAL GmbH**

Rosengarten 10  
D-22880 Wedel

Tel.: +49 - 41 03 - 9 37 76 10  
Fax: +49 - 41 03 - 9 37 76 60

[www.moeller-wedel-optical.com](http://www.moeller-wedel-optical.com)  
e-mail: [info@moeller-wedel-optical.com](mailto:info@moeller-wedel-optical.com)