

## Fluorolog-QM™ Series

Modular Research Fluorometers for Lifetime and Steady State Measurements

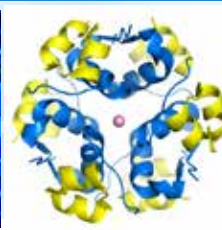
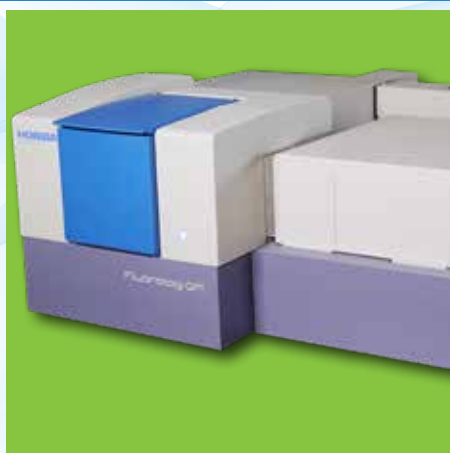
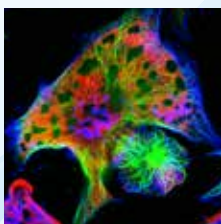

Next generation of the world's most sensitive and flexible fluorometers

[www.fluorolog.com](http://www.fluorolog.com)



# Fluorolog-QM™

**4th Generation** of the world famous  
Fluorolog Spectrofluorometer



*"A leap forward in performance, versatility and ease of use"*

## Unique Fluorolog-QM™ Benefits

- All reflective optics for optimized performance at all wavelengths
- Highest guaranteed sensitivity (*more than double that of the Fluorolog-3*)
- Excellent stray light rejection with extra-large, coma-corrected, 350 mm single, or 700 mm double additive monochromators
- New software for all steady state and lifetimes experiments, with many new features
- Extended wavelength range from deep UV to NIR
- Up to four light source types, and six detectors can be connected at once, under computer control, for ultimate lab versatility
- Plug and play, TCSPC lifetime enhancements, at speeds up to 100 MHz
- NIR steady state and phosphorescence lifetime detection to 5,500 nm
- Deep UV excitation down to 180 nm

# Fluorolog-QM™ Series

The HORIBA Fluorolog-QM series of modular research grade spectrofluorometers is the fourth generation of the world famous HORIBA Fluorolog, with the first Fluorolog introduced by Spex Industries in 1975.

The Fluorolog-QM represents the culmination of decades of HORIBA's industry-leading experience in development and manufacture of the highest level of spectrofluorometer performance and versatility.

The Fluorolog-QM, with its exquisite, optically perfect, all reflective optics, combined with a multitude of light source and detector options, and sample handling accessories, provides the highest sensitivity and greatest versatility of any spectrofluorometer.

The Fluorolog-QM can be enhanced to suit a broad array of luminescence experiments, with the industry's most extensive list of optional accessories to expand capabilities and performance, to meet all of the most demanding experimental needs.

And when you purchase a Fluorolog-QM, all of these enhancements and accessories can be added to your system at any time as your needs change, or funds become available.

With thousands operating in universities and research labs around the world, and tens of thousands of publications, Fluorolog has proven itself to be the best choice for the most demanding steady state, time-resolved, TCSPC, and PLQY applications.



# Technologies and applications

The Fluorolog-QM covers the broadest range of luminescence research.



Materials Research • Earth Sciences • C



chemistry • Food Science • Life Sciences

# Ultimate Sensitivity

The industry standard for sensitivity of a fluorometer is the signal-to-noise ratio calculated from a water Raman spectrum. Using this standardized test, the signal-to-noise ratio specification of the new Fluorolog-QM has been demonstrated to be the highest in the industry.

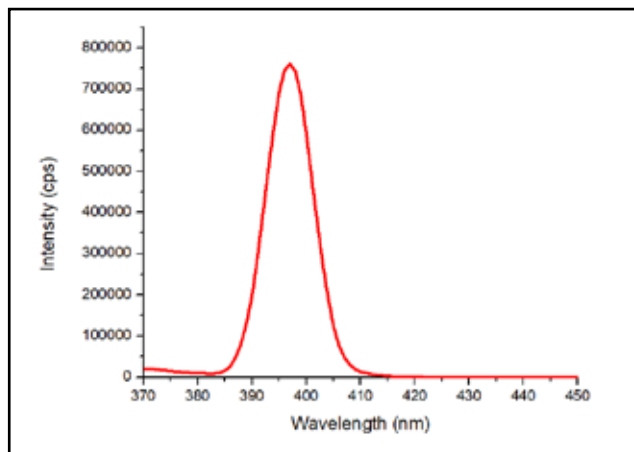

Water Raman spectrum of the Fluorolog-QM, resulting in a signal-to-noise ratio of >35,000:1! (Experimental conditions:  $\lambda_{ex} = 350 \text{ nm}$ ,  $\Delta\lambda_{ex} = \Delta\lambda_{em} = 5 \text{ nm}$ ,  $int = 1 \text{ s.}$ )

The extreme sensitivity of the Fluorolog-QM fluorometer is achieved with the lowest wattage lamp in the industry. This is a result of the intelligent engineering of the unique PowerArc™ arc lamp illuminator, featuring an ellipsoidal reflector with the highest possible light gathering efficiency of 67%, and focusing the light in a tight spot at the monochromator slit.

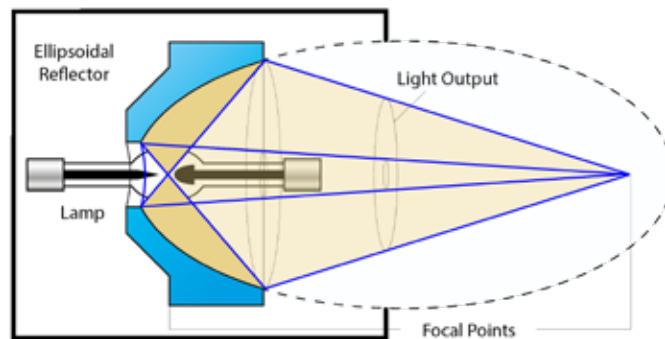

Unique 75 watt xenon lamp housing design collects 65% of all light emitted by the bulb, making it as efficient at collection of light as a traditional 450 watt xenon lamp with two collector mirrors, but with the additional benefit of having a brighter focus.

As a result, the standard 75 W Xe lamp delivers light to the sample more efficiently than higher power lamps featured by other instruments. This reduces energy waste and excessive heat generation by an overpowered light source, not to mention cost, while exceeding the sensitivity of all competitors' designs.

## Want a deeper light source?

The standard 75 watt xenon lamp emits down to 210 nm. An optional UV extended 75 watt xenon lamp provides deep UV output down to 180 nm without the need for ozone ventilation (requires gas purging).

## Want a larger wattage?

An optional 450 watt xenon housing is also available.

# Resolution

Resolution is of utmost importance to photoluminescence research. High quality resolution can reveal detailed spectral features, which is indispensable for applications in materials science and analytical chemistry. Resolution is the key to detecting very narrow lines, which is necessary to study fine interactions in inorganic materials and crystals. The Fluorolog-QM yields high quality resolution due to its innovative optical design, and very minimal optical aberrations.

The Fluorolog-QM series of spectrofluorometers use a precision-driven asymmetrical 350 mm focal length Czerny-Turner monochromator with a motorized triple grating turret and motorized flipping mirrors. More than 30 different gratings are available. Due to the combination of the computer-controlled motor with micro-stepping resolution and available grating selection, it is possible to achieve a minimum 0.02 nm step size. This step size, combined with efficient optical design, long focal length, all-reflective optics and suppressed optical aberrations allows achieving high spectral resolution of less than 0.1 nm.

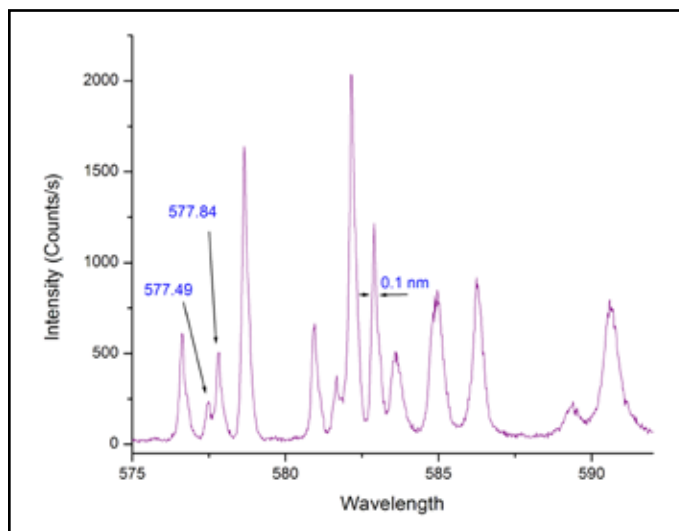

Emission scan of Dysprosium-doped YAG crystal measured at 78K in software-controlled LN cryostat illustrating excellent resolution of narrow spectral lines attained at low temperature. (Experimental conditions:  $\lambda_{ex} = 353 \text{ nm}$ ,  $\Delta\lambda_{ex} = 5 \text{ nm}$ ,  $\Delta\lambda_{em} = 0.1 \text{ nm}$ , step size = 0.022 nm, integration time = 1 s.)

# Ultimate Stray Light Rejection

## With Single or Double Additive Monochromators

Suppression of stray light is one of the most critical factors when measuring highly scattering, or low quantum yield samples. Every Fluorolog-QM Series spectrofluorometer is made with the highest quality optics to insure the lowest amount of scatter. The standard 350 mm focal length asymmetrical Czerny-Turner monochromators are coma-corrected and individually optimized for purposes as either excitation or emission monochromators. They are the largest single monochromators in the industry, ensuring the lowest amount of stray light contamination for the best detection of the true fluorescence signal. These monochromators boast an impressively high stray light rejection of  $1 \times 10^{-5}$  in a single excitation monochromator configuration.

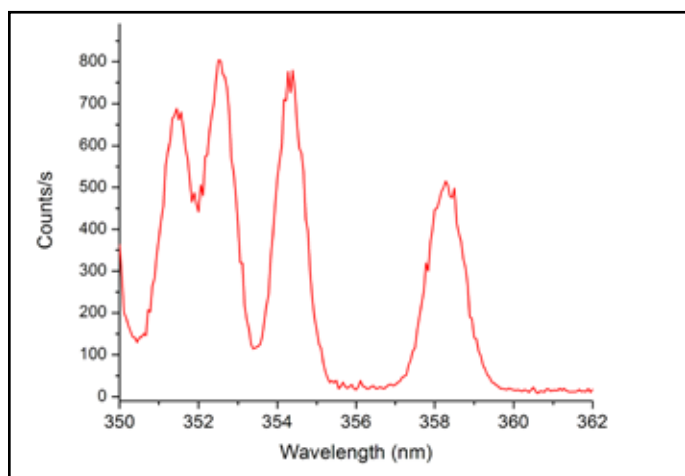

Raman spectrum of CCl<sub>4</sub> using a Fluorolog-QM with single excitation and single emission monochromators. Well-resolved peaks and no contamination from the Rayleigh scattering demonstrates the excellent stray light suppression, comparable to instruments using double monochromators! (Experimental conditions:  $\lambda_{\text{ex}} = 349$  nm,  $\Delta\lambda_{\text{ex}} = 0.7$  nm,  $\Delta\lambda_{\text{em}} = 0.7$  nm, step size = 0.05 nm, integration time = 1 s.)

For more sensitivity and higher performance, the Fluorolog-QM can also be configured with double additive 350 mm focal length monochromators for an industry-leading 700 mm of total focal length and  $1 \times 10^{-10}$  stray light rejection, achieved, in part, to a computer-controlled intermediate slit to ensure resolution and optimum stray light rejection.

The Fluorolog-QM also offers standard filter wheels on the excitation and emission channels for rejection of second and higher order signals from broad spectral scans and further reduction of stray light. This ultimate stray light performance was motivated by an increasing demand for photoluminescence spectrometers in materials science, where strongly scattering samples, such as powders, wafers and films, are routinely used. Very low stray light performance will also benefit researchers working in biological, biomedical and environmental areas where cell suspensions, protein and biomembrane solutions, or soil samples generate high levels of scattered light.

**HORIBA Scientific**

### A Double Monochromator on a Spectrofluorometer

FL-2019-8-27

#### The Importance of an Intermediate Slit on Stray Light

This HORIBA technical note demonstrates the importance of having an intermediate slit and the very important role it plays in the stray light rejection of a true double monochromator.

**Introduction**

The most compelling reason for using a double monochromator on a spectrofluorometer is to reduce the stray light level. Stray light usually refers to any radiation at wavelengths other than the selected wavelength, which may exit the monochromator. The higher the quality of the monochromator, the lower the amount of the stray light. A classic spectrofluorometer includes two monochromators, one on the illumination side to select the excitation wavelength, and a second one on the detection side to analyze the fluorescence emission.

In a fluorometer the presence of stray light may overlap with the fluorescence signal and, in the case of a very weak emission, may render the signal of interest totally obscured and undetectable. This effect can be particularly destructive for weakly emitting solids and powders, where the scatter is higher, as well as with highly scattering liquid samples, such as micellar or cell suspensions. The stray light exiting the excitation monochromator will be scattered and reflected by the sample towards the emission channel and indiscriminately detected together with the true fluorescence.

Stray light, in a spectrofluorometer, comes from the fact that no filtering element is perfect at its job. For example, every optical bandpass filter passes unwanted photons at all wavelengths, even outside of the center wavelength of the intended filter wavelength. This stray light is usually specified in a rejection of unwanted light expressed as  $10^{-1}$  for example. A 340 nm bandpass filter with  $10^{-1}$  stray light rejection passes mostly light at 340 nm, but it also passes

light at all other wavelengths, at an intensity level that is 1,000 times less. In this case if you passed a white light source through the filter with an intensity of 10,000,000 counts per second at 340 nm, then this same filter is by definition also passing 10,000 counts per second at all other wavelengths (assuming an equal intensity output at all other wavelengths). A filter with better stray light rejection will reduce transmission of these unwanted wavelengths, but again no filter is perfect at its job.

Modular research fluorometers use a scanning monochromator to provide excitation and emission spectra. These monochromators are also not perfect at rejecting stray light. If we look first at the excitation monochromator, most spectrofluorometers use a xenon arc lamp as the light source and this source is projected through an excitation monochromator to act as a tunable illuminator for light which is then directed to a sample. So if we have a monochromator that has  $10^{-1}$  stray light rejection we could imagine that if we turned the excitation monochromator to 340 nm, then we might have 10,000,000 photons per second at 340 nm that is directed to the sample, but we would also have light at all other wavelengths also directed to the sample on the order of about 100 photons per second ( $10,000,000 \times 10^{-1}$ ). All samples have varying degrees of scattering, with solids, powders and highly scattering solutions having the highest levels. Therefore, light at all wavelengths delivered to a scattering sample is scattering in all directions. If we then have the emission monochromator of the spectrofluorometer tuned to 500 nm, where the expected emission of the fluorescing sample is centered, we know that the excitation light source is delivering light at 500 nm to the sample and this light is happily passing through the emission monochromator and being detected as a "signal". However, this signal is, in fact, not the fluorescence signal from the sample, but stray,

**Tech note available upon request:**  
"Importance of an intermediate slit in the performance of a double monochromator."

# Spectral Range and Signal Detection

For most applications, the typical detector employed is a Photomultiplier Tube (PMT). The standard Fluorolog-QM configuration features a highly sensitive PMT, with the ability to operate in photon-counting, analog, Time-Correlated Single Photon Counting (TCSPC) and Single-Shot Transient Digitizer (SSTD) detector modes. The Fluorolog-QM Series offers the ability to customize the system to meet your applications needs. Photon-counting detection offers the best sensitivity in the UV-Vis region, while NIR solid state detectors offer lower dark counts and better performance in the NIR. Photon counting offers the highest sensitivity as it records single photon events. The analog detection mode acquires the current that is generated on the PMT anode, and provides for additional detection gain control. This greatly enhances the dynamic range of the instrument, especially for higher intensity signals. For NIR and IR applications, we also offer specialized PMTs and solid state detectors, such as InGaAs, InAs and InSb diode detectors that are capable of detecting out to 5500 nm. Most of these detectors can be used with pulsed light sources for time-resolved photoluminescence.

Multiple detectors can be used with a single instrument: A single monochromator will accept two, and a double monochromator, up to three detectors. The selection is done by computer-controlled steering mirrors which direct the emitted light to a selected detector. A triple motorized grating turret ensures good light efficiency for any detector range, and all reflective collection optics ensure perfect focus no matter the experimental wavelengths from the deep UV to the NIR.

# Excitation and Emission Correction

All light sources emit light that is not of equal intensity across the output spectrum, and this can lead to errors in the measurement of an excitation spectrum. The raw data must then be corrected for this discrepancy. The Fluorolog-QM utilizes a reference diode detector that has been calibrated and installed at the factory. Excitation correction is performed in real time. During an experiment, part of the excitation beam is diverted prior to reaching the sample. This fraction of photons is measured, and then the reference detector provides a correction that ensures that the fluorescence signal is independent of the excitation source characteristics, or any temporal fluctuation of the lamp intensity.

A similar phenomenon exists for emission spectra. Since the detection efficiency of the gratings, mirrors and detector is not equivalent at all wavelengths, some type of correction must be performed to account for these variations. Typically, the emission channel is calibrated at the factory with a known light source, such as a NIST-traceable standard. This information is used to construct a correction file, which is then stored locally on your computer. Multiplication of the raw data by this correction file yields the true corrected emission spectrum. This correction can be performed in real-time, or can be recalled in later analysis of the raw data and applied in the easy-to-use FelixFL software.

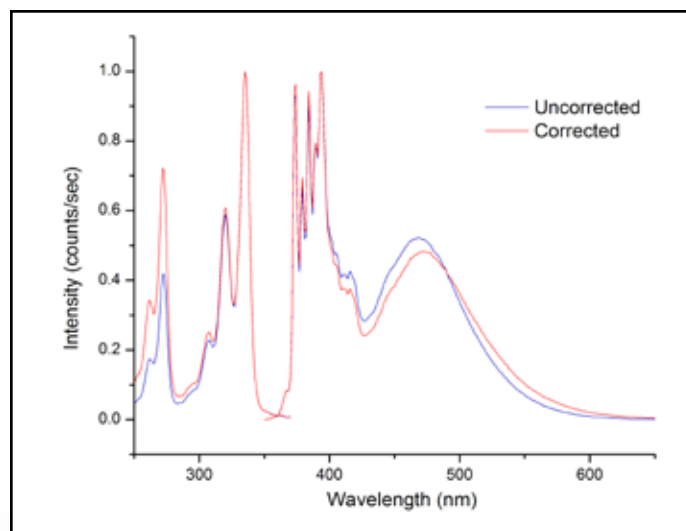

Raw and corrected Pyrene excitation and emission spectra with excimer peak present around 475 nm. Corrected data shown in red.



# Many Configurations to Fit your Specific Needs, and Modularity to Grow

The Fluorolog-QM Series features an open architecture design that provides the ultimate in versatility to adapt to any future fluorescence application needs. You can optimize the initial configuration by choosing the light source, gratings, and detectors, as well as a wide array of available accessories. The number of available configurations is almost limitless!

The Fluorolog-QM's all reflective optics sample compartment has a spacious design that provides accessibility, and can accommodate a wide selection of sample accessories. Choose from sample temperature controllers to various holders for solids, liquids and powders, dewars, integrating spheres and many other options. See the Accessories page for more details.

The open architecture design also allows for application and methodology changes. As your application needs grow, so can your Fluorolog-QM. For example, if you develop a need to measure dynamic anisotropy, you can add a second emission channel and a set of polarizers. If you want to complement your steady state data with lifetime measurements, you can add a laser or LED-based excitation source to your initial configuration. If you are interested in intracellular Ca<sup>2+</sup> after completing initial Fura-2 studies, you may decide you would like to start imaging the events. The system can be easily coupled with any fluorescence microscope. Whether you choose to add NIR detection or a second excitation source, the possible configurations are endless.

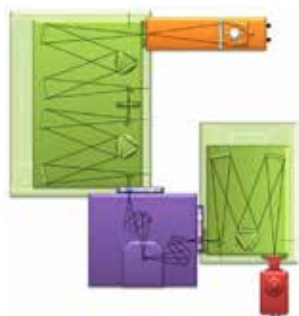

Fluorolog-QM-75-21, one of our most common configurations

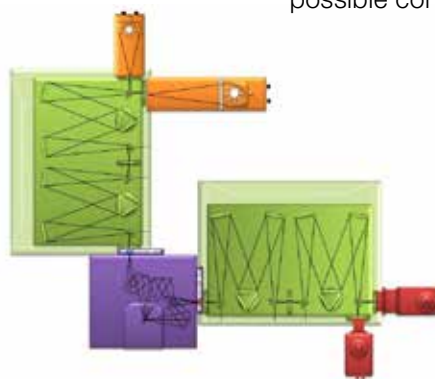

Fluorolog-QM-75-22, with optional pulsed xenon lamp, solid state NIR detector and front face collection optics

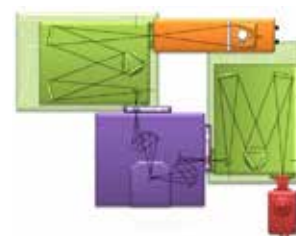

Fluorolog-QM-75-11, our smallest configuration

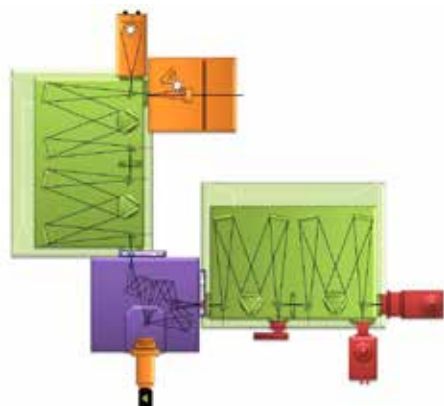

Fluorolog-QM-450-22, with optional 450 watt xenon lamp, pulsed xenon lamp, solid state NIR detector, front face collection optics, DeltaDiode laser and fast TCSPC detector

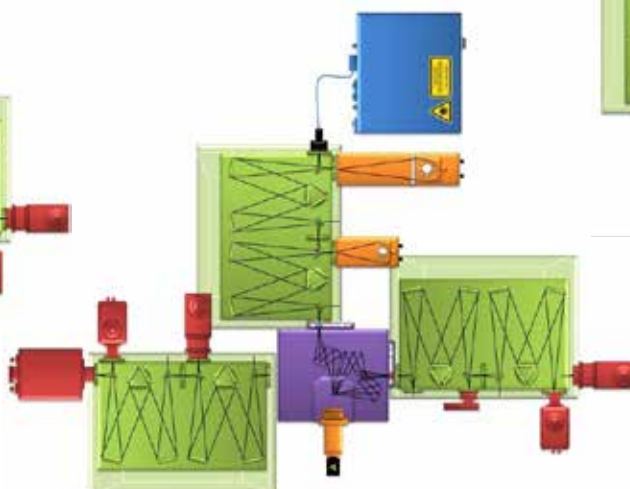

Fluorolog-QM-75-22, with second T-Format double emission monochromator, fully loaded with pulsed xenon lamp, supercontinuum laser, DeltaDiode laser and fast TCSPC detector and standard cooled PMT housing, NIR IGA detector, LN cooled NIR PMT, InAs detector and InSb detector

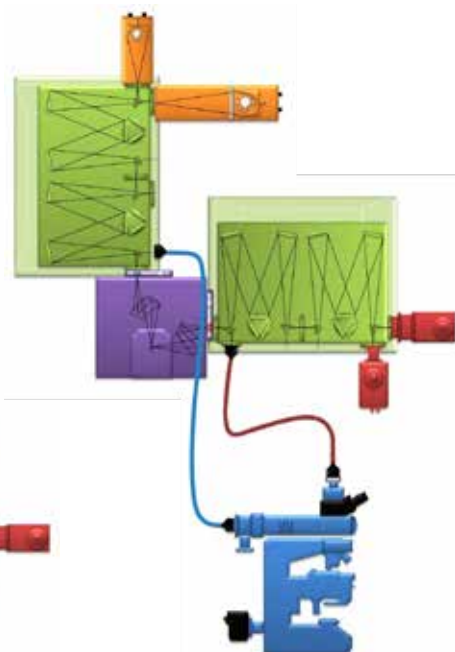

Fluorolog-QM-75-22, with optional pulsed xenon lamp and NIR IGA detector, coupled to upright fluorescence microscope

# TCSPC Lifetime Measurements

The Fluorolog-QM Series can be easily enhanced with TCSPC fluorescence lifetime capabilities. Utilizing world class TCSPC sources, electronics and detectors, the Fluorolog-QM provides the ultimate in speed, versatility and performance. The standard Fluorolog-QM PMT can be used for these additional TCSPC measurements, or it can be replaced by other detectors when shorter lifetime determination is needed, or when measurements are in the NIR region. All steady state and time-resolved control, acquisition and analyses are handled by the new FelixFL software.

## HORIBA TCSPC Benefits

- 40 years of experience in TCSPC innovation
- Industry-leading true 100 MHz system operation allows for millisecond TCSPC acquisition times
- TCSPC lifetime measurements from 25 ps to seconds
- Full control over TCSPC and steady state acquisitions with single FelixFL software package
- Measure TCSPC lifetimes, time-resolved anisotropy and TRES (Time-Resolved Emission Spectra)
- Select from our catalog of over 60 state-of-the-art compact pulsed LEDs and laser diodes for virtually any application
- For unsurpassed versatility, choose a picosecond supercontinuum laser with HORIBA's proprietary Frequency Doubler—a powerful tool for time-resolved protein studies
- Decay analysis package with multiple fitting models, including Maximum Entropy Method (MEM) lifetime distribution program

## Two Systems Can Be Better Than One!

We also offer very affordable standalone TCSPC systems. You can increase your lab's throughput by having a dedicated steady state fluorometer and a dedicated TCSPC system operating at the same time, for almost the same price as adding TCSPC to the Fluorolog-QM.

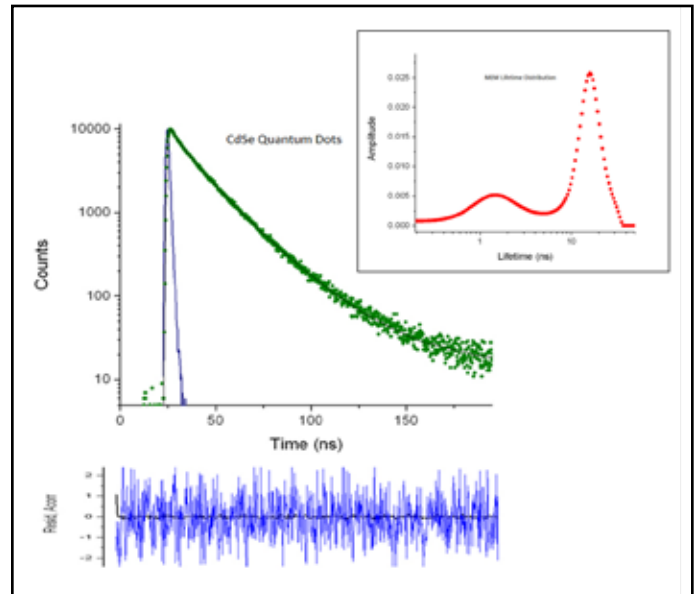

Fluorescence decay of CdSe QDots measured with the TCSPC option of the Fluorolog-QM. The MEM lifetime distribution (inset) reveals size heterogeneity of QDots.

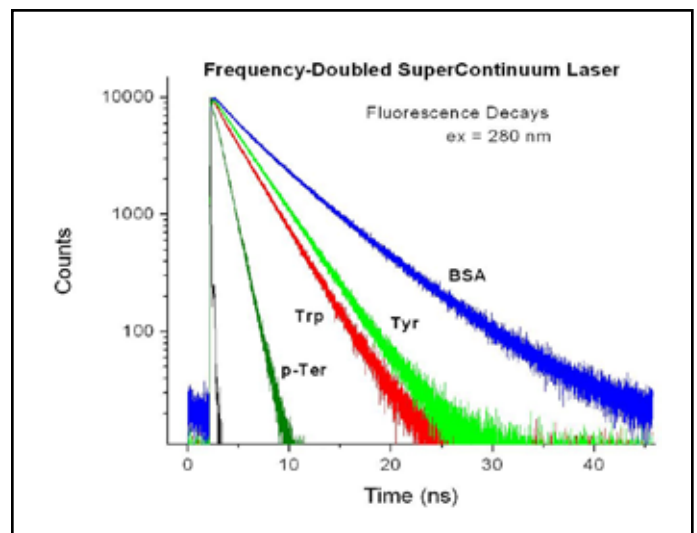

Fluorolog-QM with DeltaTime TCSPC option and frequency doubled supercontinuum laser is a perfect choice for intrinsic protein TR fluorescence.

# Phosphorescence with SSTD Detection

## Phosphorescence with a Pulsed Light Source

Every Fluorolog-QM includes the ability to collect an entire decay curve from the single flash of any TTL-triggered pulsed light source, because every system has a Single-Shot Transient Digitizer (SSTD) electronics channel. Therefore, adding a pulsed light source to a standard Fluorolog-QM provides enhanced phosphorescence with no other detection or electronics required. A pulsed light source, and the ability to integrate the signal at user-selectable time delays, are indispensable tools in discriminating spectra based on the lifetime of the respective excited state. Fluorescence emission happens on the picosecond to nanosecond time scale, while phosphorescence occurs on the microsecond to second time scale. By varying the temporal position and the width of the signal detection gate, one can selectively detect fluorescence and phosphorescence spectra, as attested by phenanthrene spectra on the accompanying figure. Here, the emission of phenanthrene in a frozen glass was measured with gradually increased time delay of the detection gate to diminish contribution of fluorescence. However, the true potential of this technique can be seen in the case of Room Temperature Phosphorescence (RTP) of RNase T1 tryptophan, where the signal was extracted by gating out the overwhelming Trp fluorescence—a task impossible with a continuous excitation source. Conveniently, the same instrument can be used to measure the phosphorescence decay of this extremely weak emission by using the Single-Shot Transient Digitizer (SSTD) function of the Fluorolog-QM interface.

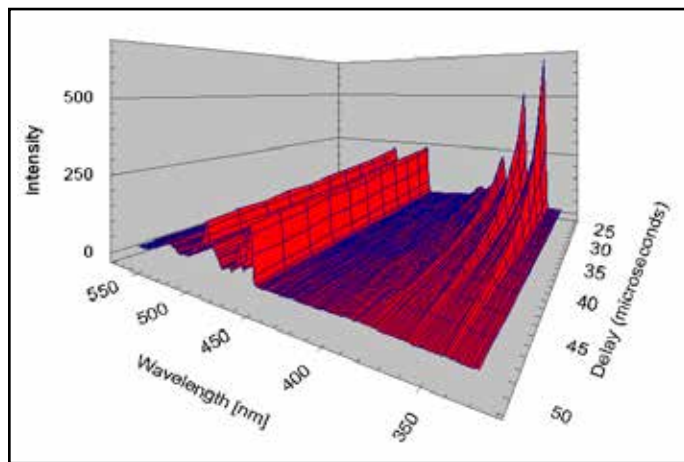

Phenanthrene at 77 K utilizing a cold finger nitrogen dewar accessory. Fluorescence and phosphorescence spectra measured while increasing the delay time (at 2  $\mu$ s increments) for signal integration.

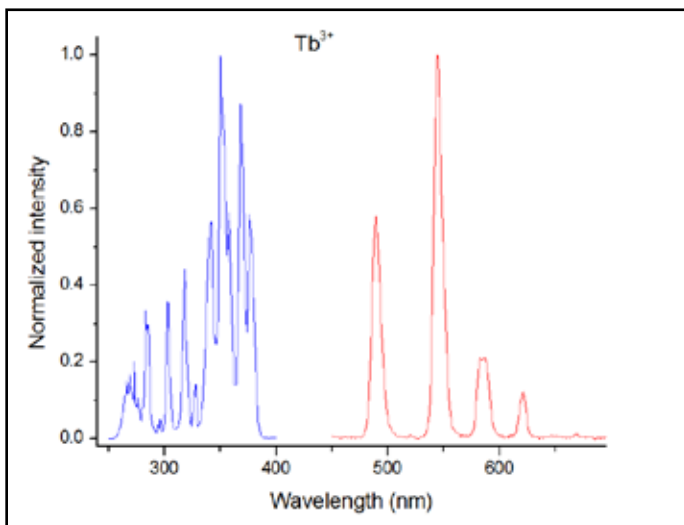

Time-resolved excitation and emission spectra measured with pulsed, broadly-tunable OPO laser under FelixFL software control

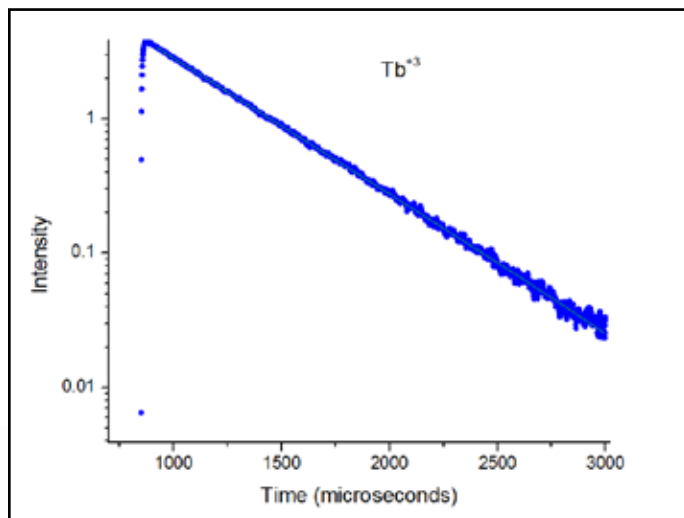

PL decay of terbium chloride excited with pulsed, wavelength-tunable OPO laser and measured with R928 PMT operating in SSTD mode. Ex = 350nm, em = 545 nm, total acquisition time = 2.5 s and recovered lifetime = 430  $\mu$ s.

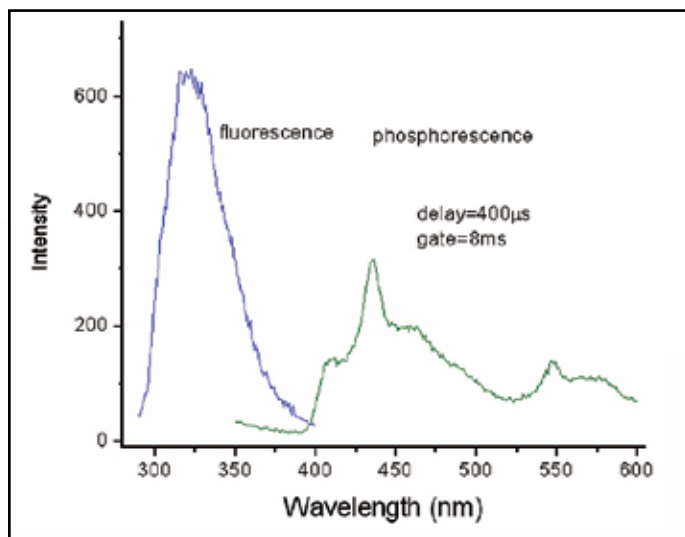

Discrimination between strong fluorescence and weak Room Temperature Phosphorescence (RTP) from RNase T1 Tryptophan by varying the temporal position and widths of the signal detection gate on a Fluorolog-QM equipped with a pulsed Xe lamp and gated detector for signal integration.

# Unique NIR Solutions for Rare Earth Samples

The SSTD phosphorescence detection mode, which is a standard capability in all Fluorolog-QM systems, offers unique performance and value for customers studying rare earth samples that for the most part emit light in the NIR. SSTD is much faster, and much more affordable than extended NIR PMT detectors which are necessary to perform NIR phosphorescence measurements using traditional boxcar electronics or TCSPC/MCS electronics.

A Fluorolog-QM can be equipped with multiple illuminators and detectors to cover the widest spectral range for both steady state spectra, and fluorescence and phosphorescence lifetimes. Consider the following configuration:

- Double emission monochromator with R928 PMT, InGaAs and InSb detectors cover 250 to 5,500 nm
- Continuous xenon lamp for steady state spectra
- 20 Hz Q-switched/OPO Opolette laser for tunable excitation from 210 to 2,200 nm
- Steady state spectra from 250 to 5,500 nm
- Single-Shot Transient Digitizer (SSTD) for phosphorescence decays over entire range from 250 to 5,500 nm

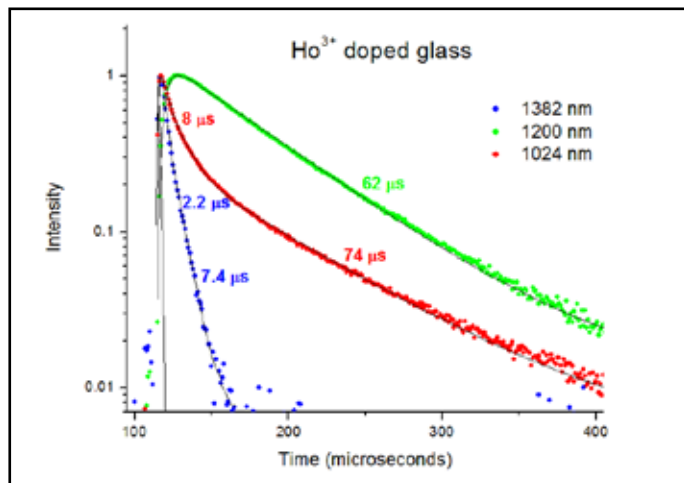

Ho ion PL decays measured with pulsed laser excitation and InGaAs detection

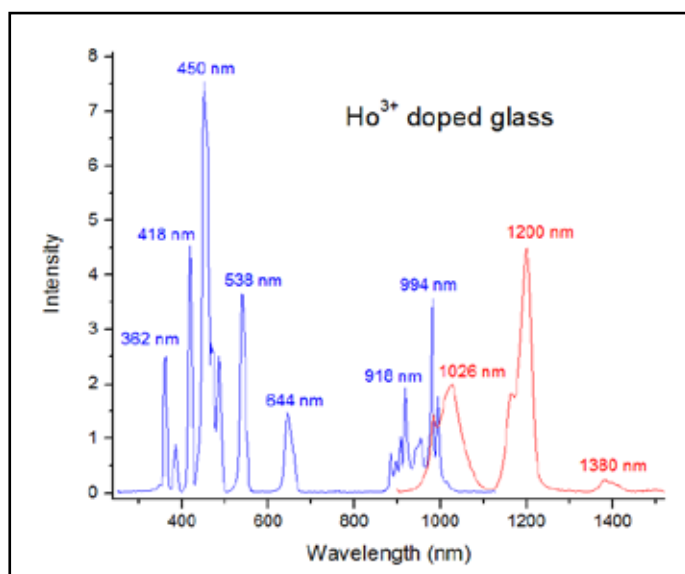

Ho ion emission and excitation spectra in NIR measured with 75 W CW Xe lamp and InGaAs detector.

The unique all reflective optics design of the Fluorolog-QM always focuses all wavelengths of light to the same precise point.

This is not true of lens-based spectrofluorometers. Lenses introduce chromatic aberrations, which means that different wavelengths of light are focused through a lens to different points. This phenomenon gets much worse at farther and farther wavelengths, so when you want to work out to 1,700 nm with an extended NIR detector, you really want to be sure you have an all reflective instrument. Only the HORIBA Fluorolog-QM provides this optimized performance at all wavelengths, from the deep UV to the NIR.

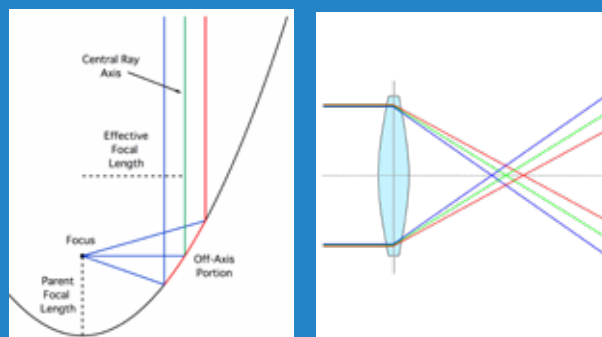

# Near-infrared Spectrofluorometry

Near-infrared (NIR) spectrofluorometry has emerged as a valuable analytical technique, especially in the fields of material research, nanotechnology, chemistry, and photomedicine. Powerful and diverse NIR capabilities are available from HORIBA as either a stand-alone research grade fluorometer, or as an upgrade to our UV-Vis steady state spectrofluorometers. There are different configurations to adapt to any research needs.

## NIR PMT-based Detectors

These detectors offer good sensitivity and can be used for steady state and TCSPC measurements. Although they can be very expensive, these detectors are the only option currently available to acquire picosecond to nanosecond fluorescence lifetimes with TCSPC electronics.

Available with four NIR PMTs for maximum spectral range coverage:

- 300–1,400 nm, LN-cooled
- 950–1,400 nm, TE-cooled
- 300–1,700 nm, LN-cooled
- 950–1,700 nm, TE-cooled

## Solid State Photodiode-based NIR Detectors

There are a variety of photo diodes available, with TE- or LN-cooling NIR detection to 5,500 nm:

- InGaAs: 800–1,700 nm
- InGaAs: 1,000–1,900 nm
- InAs: 1,000–3,450 nm
- InSb: 1,500–5,500 nm

## NIR Lifetime Measurements to 5,500 nm!

All of the detectors listed above can be used in a Single-Shot Transient Digitizer (SSTD) mode for phosphorescence lifetime measurement capability in NIR to measure lifetimes from 1  $\mu$ s to hundreds of ms. SSTD is extremely fast and offers outstanding signal-to-noise using:

- Variable high rep rate pulsed xenon lamp option for phosphorescence lifetime (NIR-TR-10)
- 3rd party pulsed Q-switched lasers
- In particular, the solid state NIR detectors offer a much better value with identical performance for phosphorescence detection than the much more expensive extended PMTS.

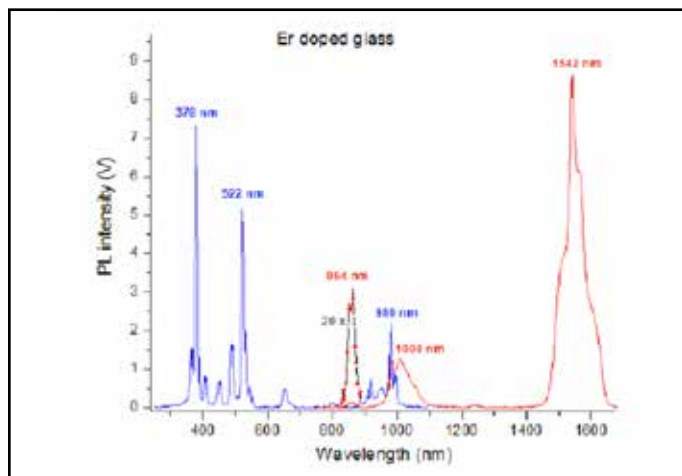

PL excitation and emission spectra of Er<sup>3+</sup> doped glass measured with the Fluorolog-QM equipped with the NIR TE-cooled InGaAs detector

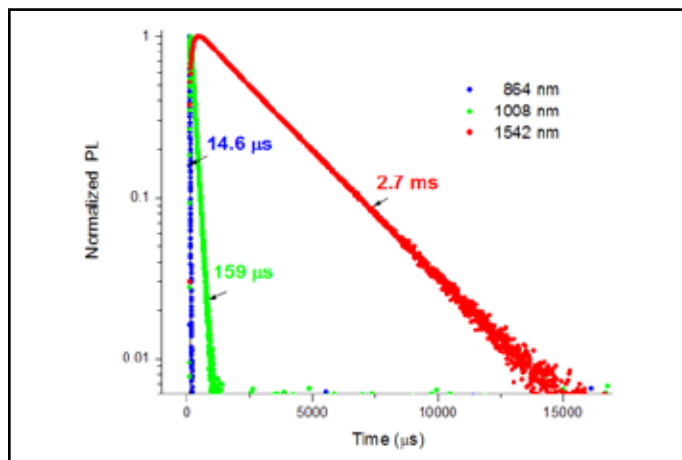

PL decays of Er<sup>3+</sup> doped glass measured with the InGaAs detector operating in the SSTD lifetime mode. Note the dramatic decrease of PL lifetimes as the transition energy increases

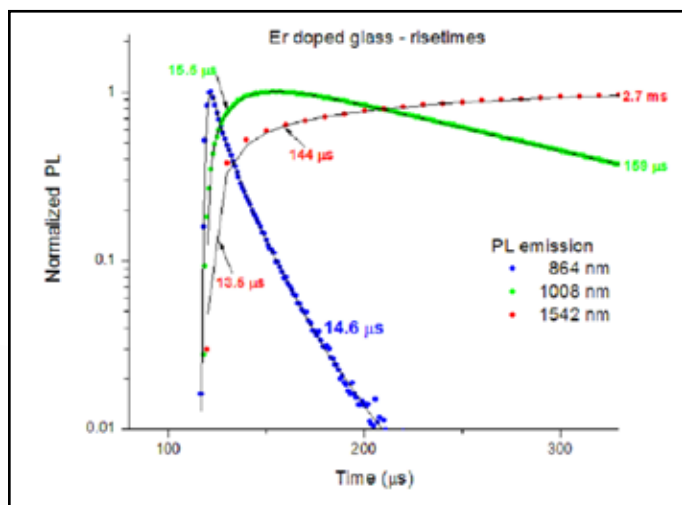

Expanded plot of Er decays showing the presence of rise times for 1008 nm and 1542 nm emission peaks

# FelixFL Software

Fluorolog-QM fluorometers come with our integrated FelixFL software to control both the instrument and accessories. Designed to be a comprehensive software platform for all steady state and time-resolved acquisition and analysis, FelixFL is also surprisingly easy to use. Connected with a USB interface, FelixFL provides a full set of data acquisition protocols, and controls the hardware for all system configurations and operating modes.



## FelixFL Controls

### Hardware Controls

- Single or double monochromators
- Triple grating turrets
- Flipping mirrors switch between different light sources and detectors
- Motorized slits
- Motorized polarizers
- Motorized multiple sample holders
- Excitation correction detector (Xcorr)
- Temperature control Peltier devices
- Cryostat
- Gain control of PMT detector
- Switching from digital to analog mode
- External devices such as stopped flow and titrator
- Pulsed light sources
- Scanning of wavelength-tunable OPO lasers
- TCSPC electronics
- Electroluminescence and photovoltaic accessories

### Macro Capabilities

FelixFL comes equipped with macro capabilities to allow for automated measurements, with simple English commands. Choose from a list of actions to make a chain of commands, or set up a loop function to eliminate the need to constantly change the acquisition settings. Set up the automation job and simply walk away, letting FelixFL execute your instructions.

### Acquisition Modes

FelixFL provides several acquisition modes for spectral and kinetic measurements:

- Excitation and emission spectral scans with user control of integration time, monochromator step, speed and wavelengths
- TCSPC fluorescence lifetimes
- Time-based scan with user-defined macro time duration and integration time
- Spectral and time-based polarization scans with full control of motorized polarizers and automated measurement of G-factor, and sample background for all polarizer orientations
- Simultaneous multi-dye measurements with pre-defined library of common fluorescence dyes or customer-defined dyes
- Synchronous excitation/emission scan
- Excitation Emission Matrix (EEM), also known as 3D spectra
- Excitation and emission ratio fluorescence for ion kinetics
- Phosphorescence decay and time-resolved excitation and emission spectra using Single-Shot Transient Digitizer (SSTD), or with optional TCSPC/MCS electronics.
- Time-Resolved Emission Spectra (TRES)
- Anisotropy decays

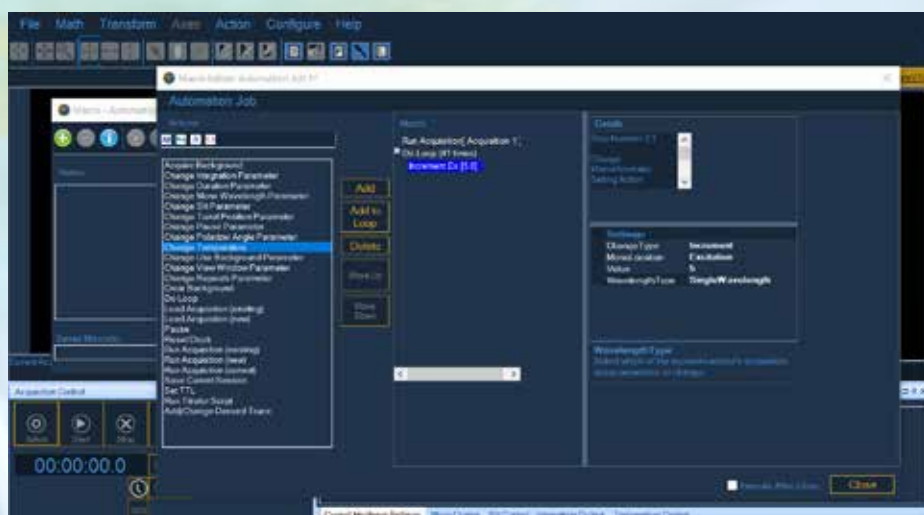

# FelixFL Analytical Capabilities



## Trace Manipulation

FelixFL also provides an extensive set of math functions that can be used for processing and manipulation of acquired data traces:

- Antilog
- Average
- Distribution average
- XY Combine
- Differentiate
- Integrate
- Linear Fit
- Linear Scale
- Logarithm
- Normalize
- Reciprocal
- Smooth
- Truncate
- Baseline
- Merge Traces
- Peak Finder

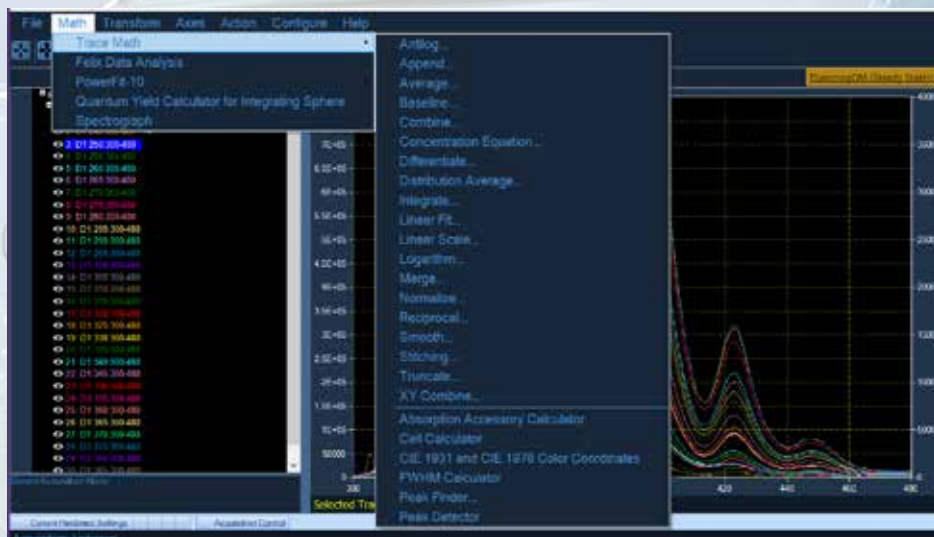

## Time-resolved Data Analysis

Fluorescence and phosphorescence decays can be analyzed with the TCSPC lifetime analysis package which includes:

- One to four exponentials
- Multi one to four exponentials
- Global one to four exponentials
- Anisotropy decays
- DAS (Decay Associated Spectra )/TRES
- Exponential Series Method (ESM) lifetime distribution analysis
- Maximum Entropy Method (MEM) lifetime distribution analysis
- Micelle kinetics
- Stretched exponential

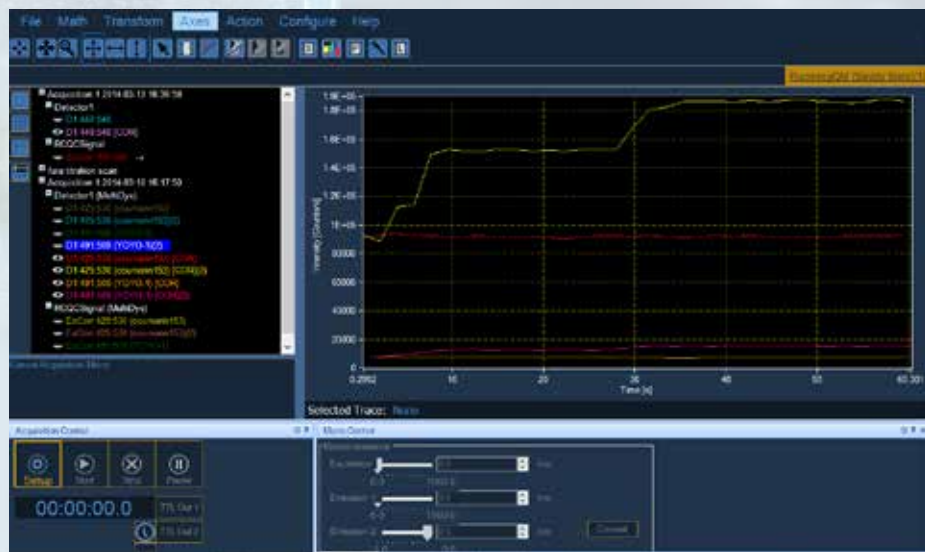

# Advanced Calculators

FelixFL also offers a special set of software functions, such as quantum yield, absorption, FRET and color coordinates calculators, as well as the software that calculates structural parameters for single-walled carbon nanotubes. These are very convenient additions to some hardware accessories, such as the integrating sphere or absorption accessory, and are also indispensable for some fluorescence applications, such as intermolecular interactions (FRET) and materials characterization.

## Single-Walled Carbon Nanotube Calculator

Carbon nanotubes can be characterized using the specially-designed NanoCal within FelixFL. NanoCal analyzes 3-D ExEm spectral maps and returns structural parameters, such as the nanotube radius and the chiral angle. Combining this easy-to-use software with Fluorolog-QM NIR options allows for full characterization of SWCNTs.

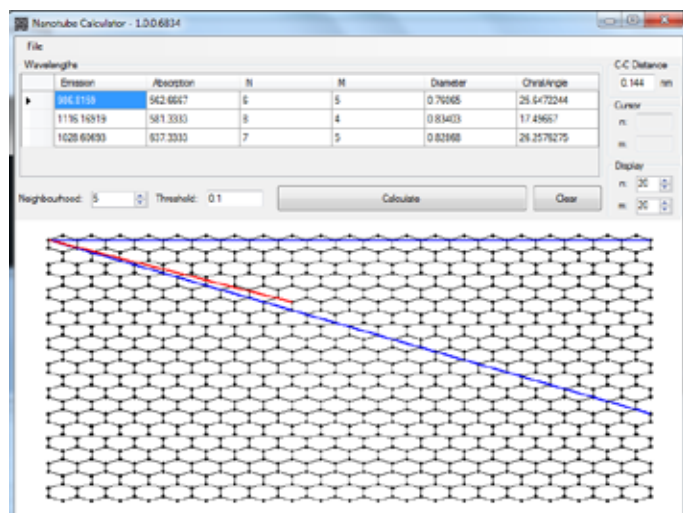
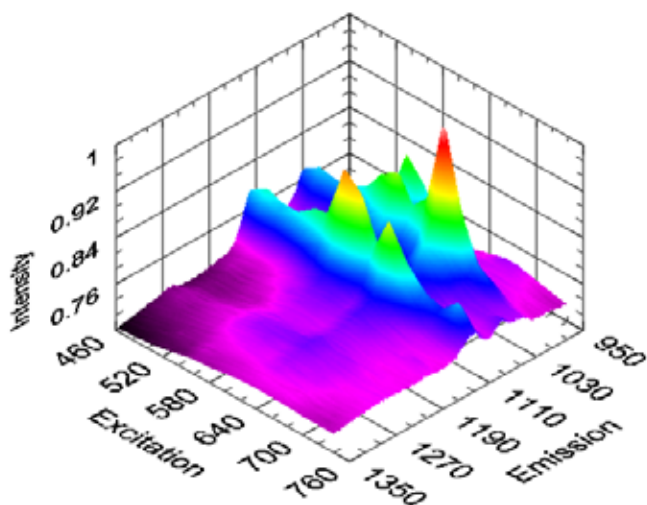

## Color Coordinate Calculator

In many applications, such as phosphors for screen displays, multi-color LEDs, fluorescent additives to consumer products, etc., there is a need to quantify a visual perception of color. FelixFL provides a Color Coordinate Calculator based on two widely accepted standards introduced by the International Commission on Illumination, CIE 1931 and CIE 1976. The CIE 1931 uses x, y chromaticity coordinates where each x, y pair corresponds to a unique color within the colored shape. The CIE 1976 uses a system with more uniform perceptual chromaticity to define the color space using u, v coordinates. Upon highlighting a spectral trace and clicking on CIE 1931 and CIE 1976 Color Coordinates, FelixFL will display both CIE pairs.

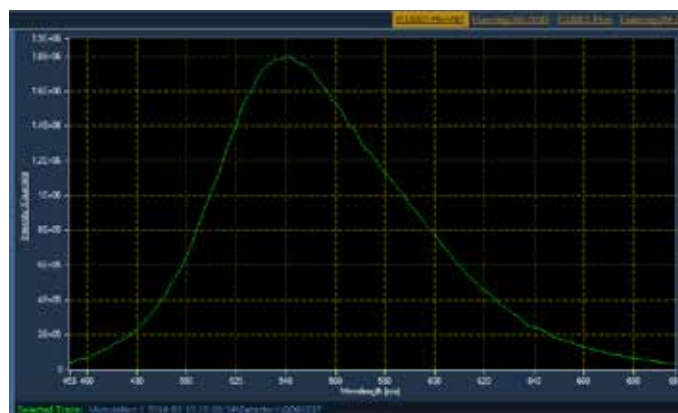
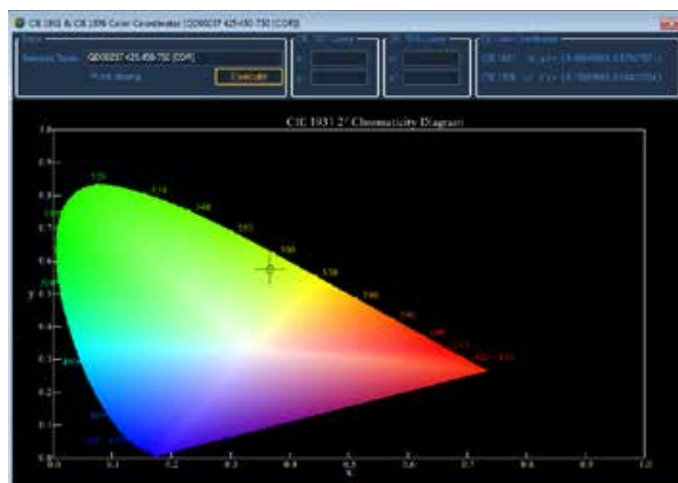



## Absorption Calculator

Absorption measurements are complementary to fluorescence. They are necessary for fluorescence quantum yield determination, and are an easy and convenient way to check the fluorophore concentration. You can compare the absorption and excitation spectra to draw conclusions about the purity of the sample. Using the built-in absorption calculator with an absorption accessory will greatly enhance the capabilities of your Fluorolog-QM fluorometer.



## Absolute Quantum Yield

Quantum yield is one of the most important parameters that characterize photoluminescence of materials. FelixFL incorporates a quantum yield calculator which, when coupled with an integrating sphere, allows you to calculate the quantum yield with ease.



## FRET

The FRET (Förster Resonance Energy Transfer) technique provides information about molecular distances, interactions in macromolecular systems, binding, diffusion, sensing, etc. FRET happens when an excited donor molecule transfers its energy to an acceptor in the ground state. FRET is essentially a molecular ruler, where distances are scaled with the Förster critical radius  $R_0$ , which is a unique parameter for a given donor-acceptor (D-A) pair, defined by spectroscopic parameters of the pair and their environment. Once the  $R_0$  is known, and the FRET efficiency is determined experimentally, the D-A distance and the FRET rate constant can be calculated. From spectra or TCSPC data, FelixFL provides an easy and convenient way of calculating all relevant FRET parameters, including  $R_0$ .

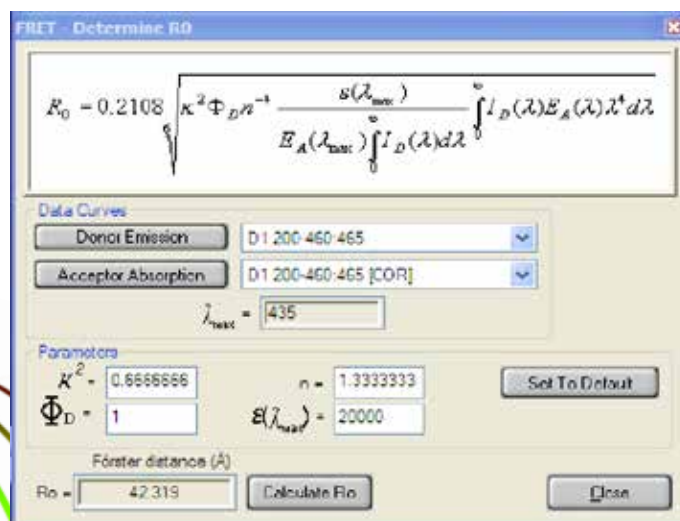

# Accessories

## Absolute Quantum Yield Measurements

Photoluminescence Quantum Yield (PLQY) measurements are critical for a broad range of applications, including new material development, photovoltaics and the development of new fluorescence probes. With thousands of PLQY citations around the world, HORIBA has long been recognized for its superior quality of PLQY performance for the most demanding applications.

The Fluorolog-QM continues this tradition and now offers two different PLQY integrating sphere options so you can choose which is best for your application: An 81 mm diameter sphere tray assembly that directly couples inside the sample compartment, and our larger 152 mm diameter external sphere, called Quanta-Phi, which is fiber-coupled to the Fluorolog-QM. Both spheres are provided by HORIBA with sphere correction curves, and the PLQY accuracy of the entire Fluorolog-QM with either sphere is validated with two different, globally accepted PLQY standards. Both PLQY spheres allow for accurate PLQY determination, even below 1%, depending on the sample. The smaller sphere is an excellent value option for a customer with a limited budget who still wants a very accurate PLQY system. The larger sphere has benefits inherent with its larger size, in particular, slightly better precision.



Quanta-Phi  
External Fiber-coupled Integrating Sphere



K-Sphere-Petite  
Internal, Directly-coupled Integrating Sphere

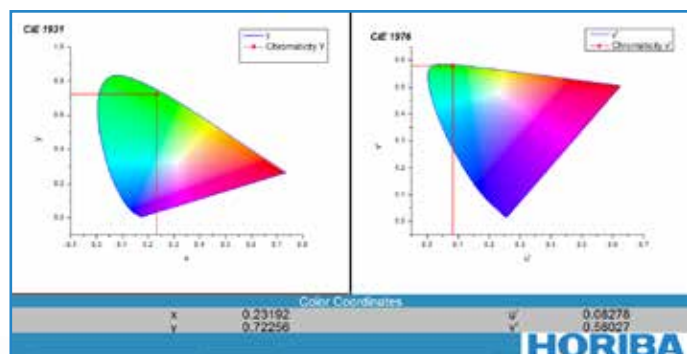

FelixFL software also automatically generates colorimetric CIE 1931 and 1976 values for your sample.

## Polarization

Adding optional polarizers to a Fluorolog-QM allows you to study molecular rotation. This indirect measure of the local viscosity gives information on sample aggregation, structural changes, molecular binding, and other mechanisms. The Fluorolog-QM polarizers are Glan-Thompson prisms, providing the highest efficiency across the whole wavelength range from the UV to the NIR.

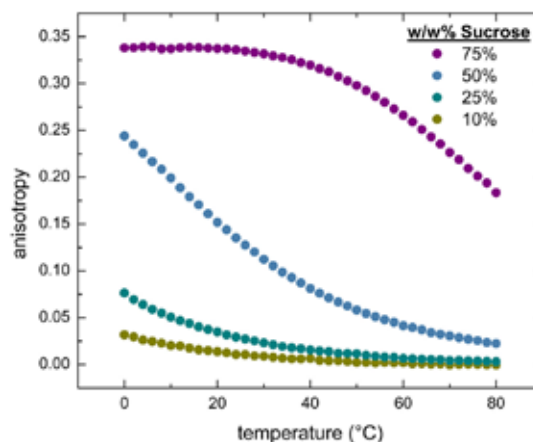

Fluorescein dissolved in four aqueous solutions of sucrose. With increased solution temperature, viscosity decreases, yielding faster rotation times and correspondingly lower anisotropies. Similarly, anisotropy is an excellent tool for understanding changes in macromolecule shape, as well as molecular binding.

## Absorbance/Transmittance Accessory

There are two options to choose from to add absorbance/transmission to the Fluorolog-QM. Both are single beam implementations, meaning they require two sequential measurements, one of the buffer/solvent, and then one of the sample in the buffer.

The first is an absorbance accessory which is a cuvette sample tray accessory that has a photodiode that is mounted on the front of the sample tray accessory. This silicon photodiode detects from 200 to 1,000 nm and allows for simultaneous absorbance/transmission measurements along with fluorescence.



Fluorolog-QM-Trans absorbance transmission accessory

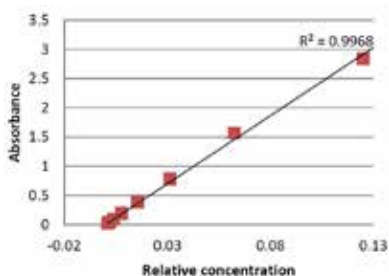

Correlation of absorbance to concentration

The second accessory (ABS-ACC) is a lower cost sample holder that mounts a 45 degree reflector into the standard cuvette sample holder and has a cuvette holder positioned in line with the standard fluorescence emission path at 90 degrees from illumination. In this way, a sample can be placed in this accessory's cuvette holder and absorbance/transmission can be measured with the standard fluorescence emission detector channel. This accessory allows for simple switching from absorbance to fluorescence, but does not allow for both to be measured simultaneously.



ABS-ACC cuvette absorbance transmission accessory

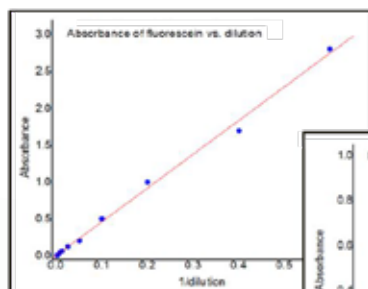

Linear dependence of fluorescein absorbance vs. the dilution factor measured with the Fluorolog-QM equipped with the ABS-ACC accessory.

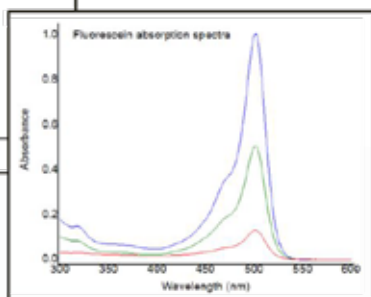

Fluorescein absorption spectra measured with the Fluorolog-QM equipped with the ABS-ACC accessory.

## Microvolumes

Measure ultra-low sample volumes with easy sample recovery.

HORIBA's Microsense, the most advanced microliter accessory on the market, is designed to get cuvette-quality steady state or lifetime data from just 1-5  $\mu\text{L}$  of sample.

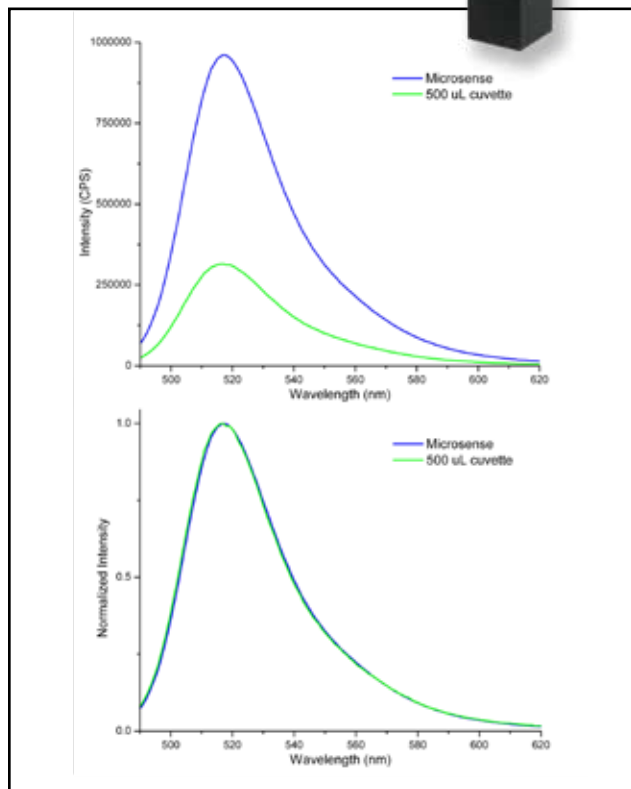

5  $\mu\text{L}$  of sample in Microsense vs. 5  $\mu\text{L}$  of sample diluted into 500  $\mu\text{L}$  of Alexa Fluor<sup>®</sup> 488 labelled IgG. Undiluted Microsense sample shows 3x signal intensity, and the same spectral shape.

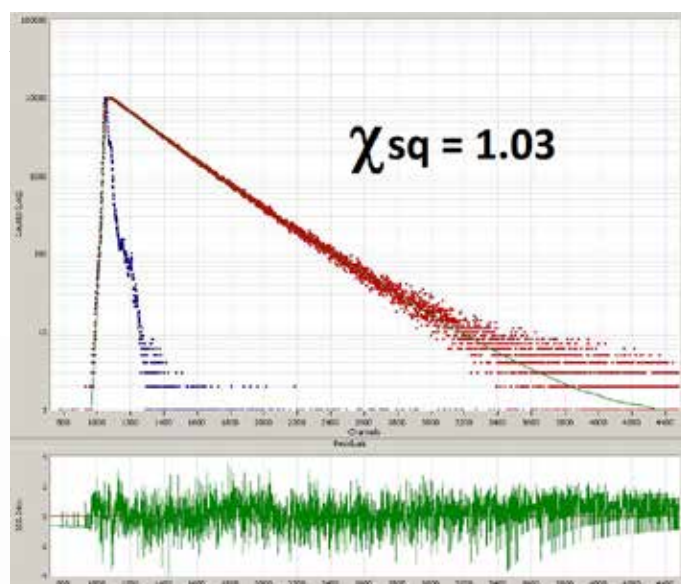

Using the Microsense 5  $\mu\text{L}$  of Alexa Fluor 488 labeled IgG is enough to get a nice TCSPC decay curve on a Fluorolog-QM equipped with TCSPC electronics.

## Peltier-based Heated/Cooled Cuvette Holders

Rapid temperature control in single or multiple cuvette models with built-in magnetic stirring.

Precise temperature control for precise data on your protein folding, micellization, solubility, conformation, phase, and rotational transitions.

Rapidly vary sample temperature over a range of -25 to 105° C (-40 to 150° C optional). Fluorolog-QM software also simplifies automating temperature dependence measurements, including complex ramps and profiles.

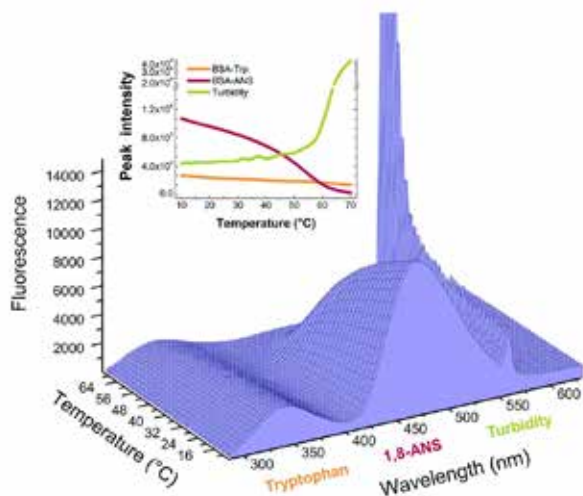

Thermal unfolding of bovine serum albumin in PBS and 1,8-ANS followed using three observables: The quenching of intrinsic tryptophan fluorescence by water, the quenching of the 1,8-ANS, and the increased 2nd order scattered light which reports turbidity from protein aggregation.

## Temperature Bath

An alternative to Peltier-based units for fixing a temperature without the need for variable temperature control, such as clamping biological sample temperature. Better precision (0.01° C), range (-25 to 100° C) and long term stability, but without temperature ramping.



## Optional LN<sub>2</sub> and He Cryostats

For greater temperature range and sample type flexibility, the Fluorolog-QM supports various cryostats offering temperature control down to 4 K.



## Economic LN Temperature Dewar Accessory

Cryogenic temperatures enable measurements of fine structure, enhanced phosphorescence, and rare conformations/states often not possible at room temperature. This low cost accessory readily permits measurements of liquid or solid samples at 77° K.

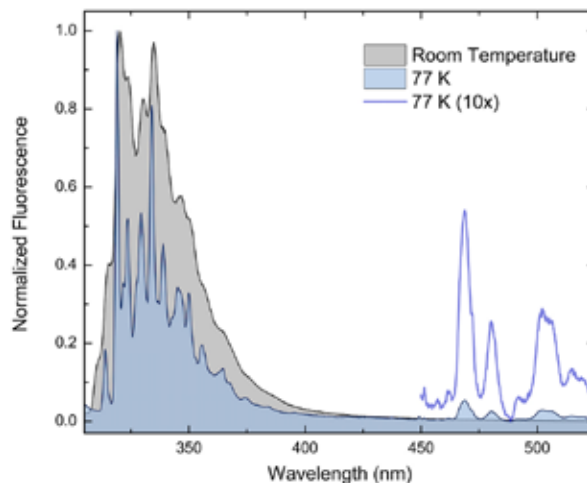

Temperature can add thermal broadening to fluorescence spectra and increase phosphorescence quenching. Spectra of naphthalene dissolved in methanol measured at room temperature (298° K) and in a liquid nitrogen dewar accessory (77° K). The low temperature spectrum reveals rich vibrational structure and longer wavelength phosphorescence. Phosphorescence peaks are also shown magnified 10x for clarity.

## Other Accessories

The Fluorolog-QM Series includes the most comprehensive line of accessories that enable researchers to extend the utility of their instrument to as many experiments as possible. The following is a partial list of accessories available, in addition to those previously discussed.

- Solid sample holder designed for viewing front-face fluorescence of thin films, powders, pellets, paper, fibers, or microscopic slides. Variable alignment angle.
- 2- and 4-position thermostated sample holder with magnetic stirring bar
- 4-position sample holder with magnetic stirring bar
- Auto-titrator (injector) dual syringe, dual valve
- Hi-tech SFA-20 stopped flow, rapid kinetics accessory
- Sealed water standard in scratch-proof housing for water Raman S/N verification
- Emission correction factor kit
- Excitation correction factor kit
- Purge port, quartz windows for sample compartment for use with nitrogen purging
- Up conversion laser accessories
- 250 µl reduced volume cell
- 500 µl cuvette 5x5 mm
- 20 µl HPLC flowcell

# Specifications

The following specifications are for the standard Fluorolog-QM-75-22 system. Options and upgrades are available upon request.

Signal-to-Noise Ratio	>35,000:1 FSD water Raman signal-to-noise ratio <sup>1</sup>
Data Acquisition Rate	1,000,000 points/sec. to 1 point/1000 sec.
Inputs	2 photon-counting (TTL); 4 analog (+/- 10 volts); 1 analog reference channel (+/- 10 volts); 2 TTL
Outputs	2 analog (+/- 10 volts); 2 TTL
Emission Range with Standard PMT	185 nm to 900 nm (optional to 5,500 nm)
Light Source	High efficiency "ECO" friendly continuous 75 W xenon arc lamp (Optional 450 W xenon)
Excitation and Emission Monochromators	700 mm, triple grating, coma-aberration corrected, asymmetrical, excitation or emission optimized, Czerny-Turner design with computer-controlled slits at entrance, intermediate plane and exit.
Slits	Computer-controlled, continuously adjustable
Excitation Grating	1200 line/mm 300 nm blaze, (Up to two optional gratings can be ordered)
Emission Grating	1200 line/mm 400 nm blaze, (Up to two optional gratings can be ordered)
Wavelength Accuracy	+/- 0.3 nm
Minimum Step Size	0.01 nm (grating dependent)
Standard Detection	-20 degrees Celsius cooled, 1600 Volt PMT housing; Multimode: Photon counting, 3 analog (fast, medium, slow response), Direct and Single-Shot Transient Digitizer (SSTD) mode, and Time Correlated Single Photon Counting (TCSPC)
System Control	Computer interface with FelixFL spectroscopy software
Lifetime Range	5 ps to seconds with appropriate time-resolved accessories

HORIBA Instruments has a policy of continuous product development, and reserves the right to amend part numbers, descriptions and specifications without prior notice.

1. The experimental conditions for ultrapure water Raman emission scan were as follows.

**Fluorolog-QM-75-22 Spectrofluorometer (75 watt xenon lamp, double excitation and double emission monochromator, cooled PMT housing with R928 PMT)**

- Excitation 350 nm with 5 nm bandpass
- Emission 365–455 nm with 5 nm bandpass
- Emission wavelength step Interval 0.5 nm
- 1,200 g/mm excitation and emission gratings
- -20° C cooled R928 PMT
- 1 second integration time
- Single emission scan (no repeats)
- No smoothing of data points
- No optical filters of any kind

# Simultaneous Multichannel Detection

Single channel PMT detectors provide the best possible spectrofluorometer performance in terms of sensitivity, spectral resolution, dynamic range and temporal resolution for TCSPC lifetimes. However, there are some applications where the speed of a multichannel detector, such as a CCD, is very important. One such application is in the acquisition of a three dimensional excitation emission matrix, or EEM. EEMs are used for component analysis, however a scanning PMT fluorometer takes a much longer time to acquire an EEM than does a CCD-based instrument.

HORIBA has developed a number of fluorescence instruments based on instantaneous acquisition of the fluorescence emission with a multichannel detector.

Two are dedicated CCD-based benchtop fluorescence and absorbance spectrometers: Duetta is an entry level fluorescence and absorbance spectrometer, and Aqualog is a more advanced fluorescence and absorbance spectrometer that is better suited for industrial QC/QA applications, such as water characterization, wine and beverage phenolics and at-line and end point pharmaceutical analysis. Both systems provide real time inner filter effect correction by simultaneously acquiring absorbance-transmission, so in fact, in addition to a traditional EEM, both can also acquire an A-TEEM™ (Absorbance-Transmission EEM).

The HORIBA Nanolog is a modular high-end research fluorometer that can be equipped with a wide array of detector options, including UV-Vis multichannel CCDs, NIR multichannel IGAs, and any number of single channel detectors. The Nanolog is fully customizable to suit almost any individual luminescence research need.

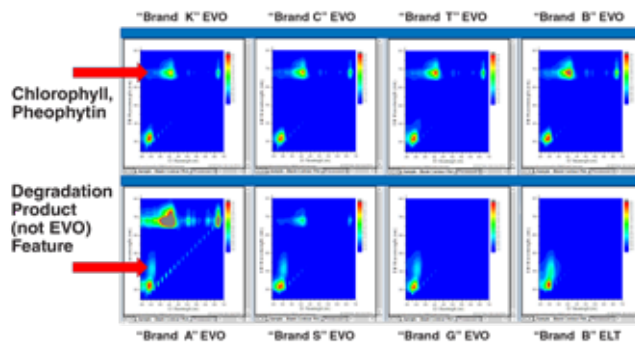

Chlorophyll and degradation products can easily be seen in the Aqualog A-TEEM fingerprints of some of these commercial EVO-labelled olive oils.

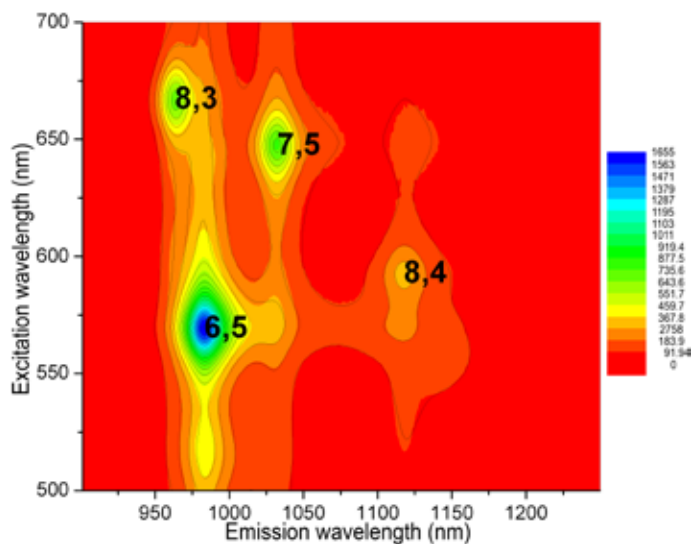

EEM of NIST sample acquired on Nanolog, with important SWCNTs (>10% of maximum) labeled using (n, m) coordinates.



# Family of fluorescence systems



# HORIBA FLUORESCENCE

Scientific

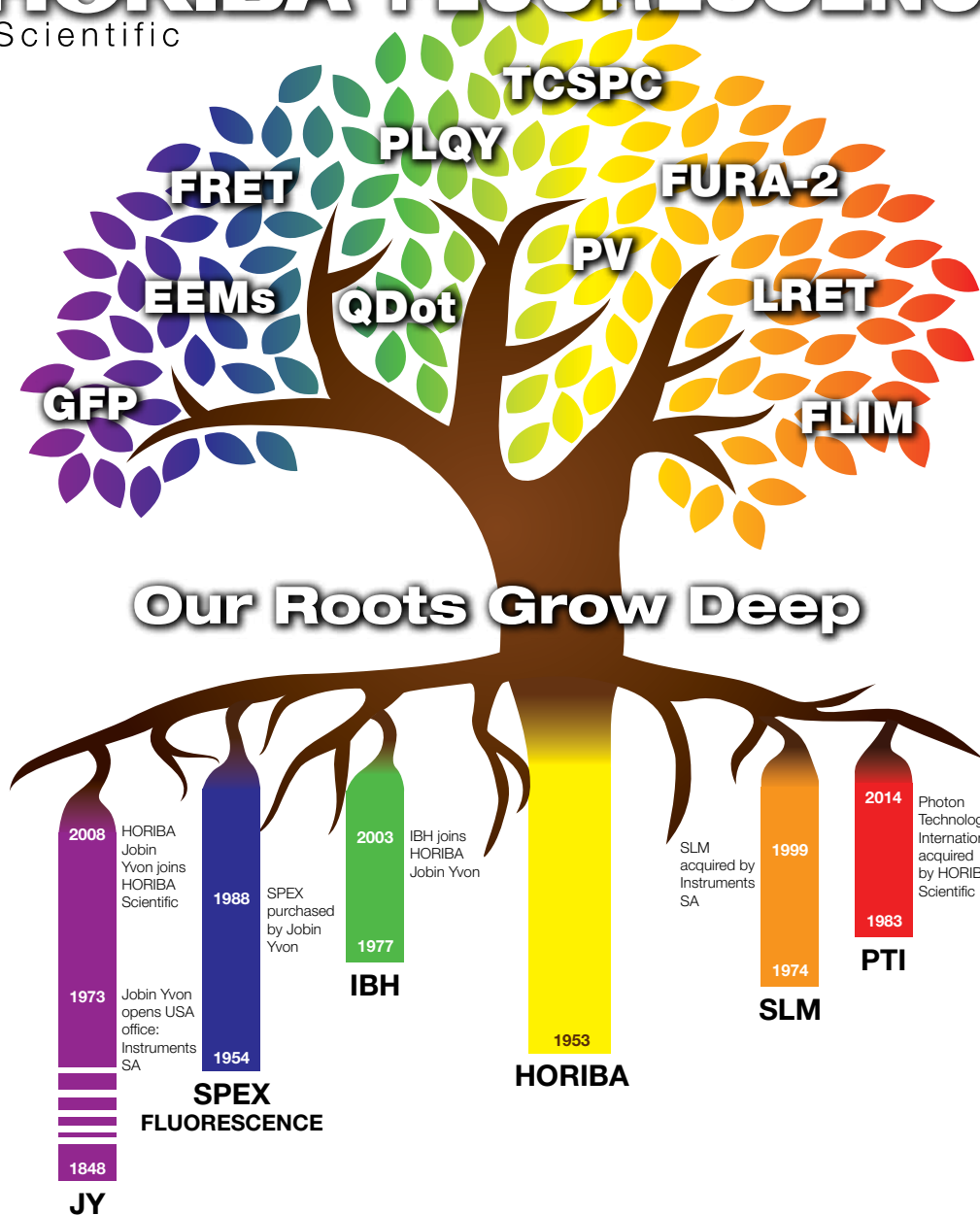

FluoroMax is a registered trademark in the United States of HORIBA Instruments Incorporated.

HORIBA Scientific has a policy of continuous product development, and reserves the right to amend part numbers, descriptions and specifications without prior notice.

[horiba.com/fluorescence](http://horiba.com/fluorescence)  
[info.sci@horiba.com](mailto:info.sci@horiba.com)

**HORIBA**  
 Scientific

- France:** HORIBA Jobin Yvon S.A.S., 16-18 rue du Canal, 91165 Longjumeau cedex - Tel. +33 (0)1 69 74 72 00 - Fax. +33 (0)1 69 09 07 21 - Email: [info-sci.fr@horiba.com](mailto:info-sci.fr@horiba.com)
- USA:** HORIBA Instruments Inc., 20 Knightsbridge Road, Piscataway, NJ 08854 - Tel. +1 732 494 8660 - Fax. +1 732 549 5125 - Email: [info-sci.us@horiba.com](mailto:info-sci.us@horiba.com)
- Japan:** HORIBA Ltd., 2 Miyachigashi, Kisshoin, Minami-ku, Kyoto 601-8510 - Tel. +81(75)313-8121 - Fax. +81(75)321-8312 - Email: [info@horiba.co.jp](mailto:info@horiba.co.jp)
- Germany:** HORIBA Jobin Yvon GmbH, Neuhofstrasse 9, 64625 Bensheim - Tel. +49 (0) 6251 8475 0 - Fax. +49 (0) 6251 8475 20 - Email: [info-sci.de@horiba.com](mailto:info-sci.de@horiba.com)
- Italy:** HORIBA Jobin Yvon Srl., Viale Luca Gaurico 209 - 00143 Roma - Tel. +39 06 51 59 22 1 - Fax. +39 06 51 96 43 34 - Email: [info-sci.it@horiba.com](mailto:info-sci.it@horiba.com)
- UK:** HORIBA UK Ltd., Kyoto Close, Moulton Park, Northampton, NN3 6FL - Tel. +44 (0)1604 542 500 - Fax. 44 (0)1604 542 699 - Email: [info-sci.uk@horiba.com](mailto:info-sci.uk@horiba.com)
- China:** HORIBA (China) Trading Co. Ltd., Unit D 1F, Bldg A, Srynnex International Park, No. 1068 West Tianshan Road, Shanghai 200335 - Tel. +86 (0)21 6289 6060 - Fax. +86 (0)21 6289 5553 - Email: [info-sci.cn@horiba.com](mailto:info-sci.cn@horiba.com)
- Singapore:** HORIBA Instruments (Singapore) Pte Ltd. 3 Changi Business Park Vista #01-01 AkzoNobel House 486051 Singapore - Tel. +65 (0)6 745 8300 - Fax. +65 (0)6 745 8155
- Taiwan:** HORIBA Taiwan Inc., 8F-8, No.38, Taiyuan St., Zhubei City, Hsinchu County 30265 - Tel. +886 3 5600606 - Fax. +886 3 5600550 - Email: [info-sci.tw@horiba.com](mailto:info-sci.tw@horiba.com)
- India:** HORIBA India Private Limited Bangalore Office No.55, 12th Main, Behind BDA Complex, 6th sector, HSR Layout, Bangalore South, 560102 Bangalore Tel. +91 80 41273637
- Brazil:** HORIBA Instruments Brasil Ltda., Rua Presbítero Plínio Alves de Souza, 645, Loteamento Polo Multivias Bairro Jardim Ermida II, Jundiá São Paulo CEP 13.212-181 Tel. +55 (0)11 2923 5400 Fax. +55 (0)11 2923 5490 - Email: [infocientifica.br@horiba.com](mailto:infocientifica.br@horiba.com)
- Other:** Tel. +33 (0)1 69 74 72 00 - Email: [info.sci@horiba.com](mailto:info.sci@horiba.com)