



# GONIOMAT Product Line Overview

The highly precise goniometers of the **GONIOMAT** product line are an indispensable measurement tool for inspection of incoming and outgoing parts as well as for small, medium or large volume production. They enable the angle measurement of optical prisms, polygon mirrors, wedges and angle gauge blocks with a measuring accuracy up to 0.4 arcsec.

The high measuring accuracy and reproducibility of the measurement results are based on the combination of a precision rotary table with an angle encoder, a highly precise electronic autocollimator and a software-based image evaluation with innovative measurement data analysis. This enables the evaluation of autocollimation image and angle position of the encoder in 3D-space ("virtual tilt table"), which makes the time-consuming adjustment of the specimen using an adjustable tilt table no longer necessary. Additionally, the algorithm is able to detect multiple reflections and exclude the non-relevant reflections during the analysis.

## All instruments contain:

- A highly precise electronic autocollimator with large measurement range
- A highly precise rotary table with integrated angle encoder
- A support table, kinematically-mounted on the rotary table
- The software **GONIOMATIK**
- Special hardware for ambient light suppression
- Single-cable USB connection to a PC

## The software **GONIOMATIK** includes:

- Integrated ray-tracing analysis

## The combination of hardware and software enables:

- Automatic separation of multiple reflected images
- Suppression of distracting retro reflections
- Determination of pyramidal errors

The **GONIOMAT** product line includes different devices that cover a broad spectrum of applications and requirements. All devices will be delivered with the software **GONIOMATIK**.



The main differences between the **GONIOMAT M** and **GONIOMAT A** line are the manually or automatically driven rotary tables and the different accuracy classes. The **GONIOMAT M5 XL** is especially designed for the measurement of large specimens.

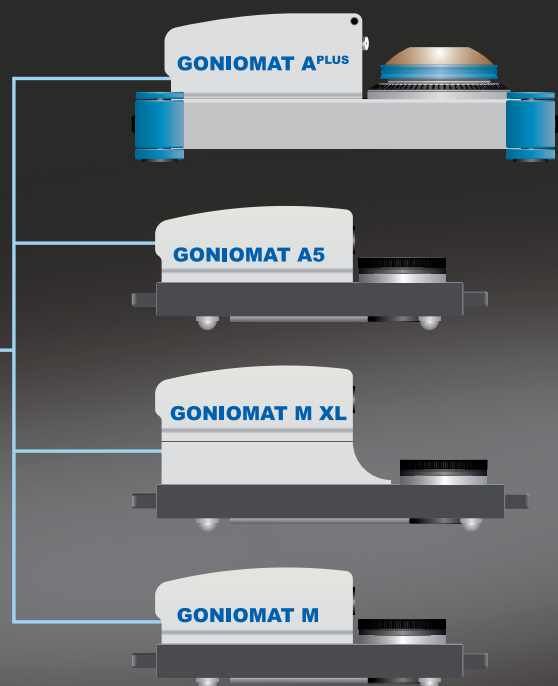

# GONIOMAT Product Line

## Typical Applications

### Angle Measurement

For mass production of prisms and angle gauge blocks the measurement of angular accuracy can take place on the production floor. In addition, the pyramidal error to the base will be determined. The software can report both: the result of a single measurement and the mean and distribution values of production lots. This information can be used to verify production consistency.

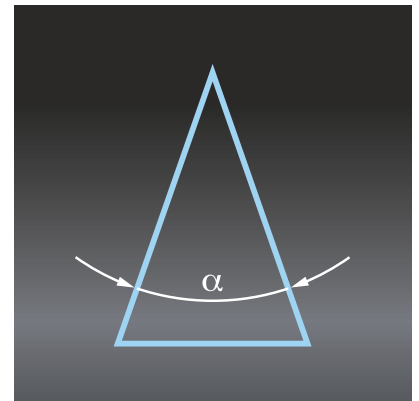

### Prism Measurement

All angles of a prism can be measured for compliance to technical specifications in one measuring sequence. The reflections of all prism surfaces are detected. Afterwards surface, pyramidal and deflection angles are calculated. Pyramidal error can be reported according to any of various ISO definitions, depending on the application. The deflection angle can be reported for any wavelength, not only for the measurement wavelength. Setting a tolerance level makes incoming and outgoing inspection easier.

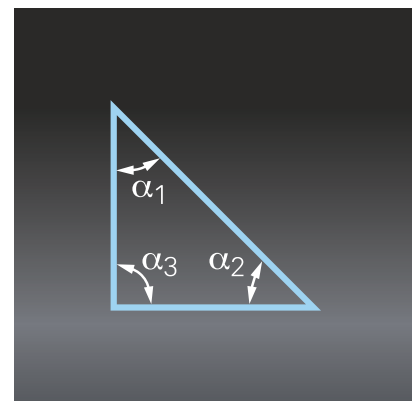

### Polygon Mirror Measurement

During a polygon mirror measurement the angle between the surfaces of a polygon are determined according to VDI 2605. The software reports the cumulative angle error, the angle error relative to the first face and between adjacent faces. The software also includes the rosette method, which has the smallest measurement uncertainty. In addition, the pyramidal error can be reported.

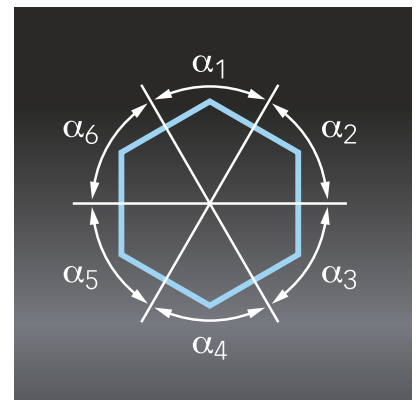

### Wedge Angle Measurement

Three evaluation methods are available for the measurement of plane-parallel windows or wedges: The evaluation of the double image in reflection, measurement by turn-around, measurement against a mirror in transmission. The evaluation method used depends on whether the user requires a fast measurement, a refractive index-independent measurement or a high-accuracy measurement, respectively. The orientation/direction of the wedge will be given for all the methods. This can be used for marking the thick side of the wedge. Additionally, the deflection angle can be calculated by the software.

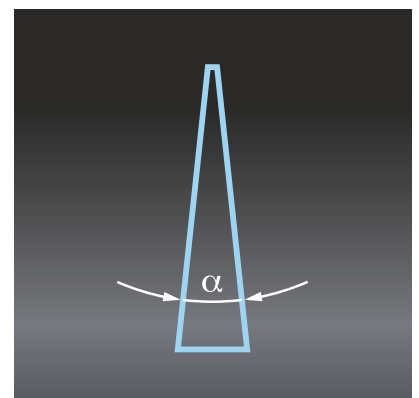

### Deflection Angle Measurement

The deflection angle can be measured for all planar optical components and assemblies. Similar to the wedge angle measurement, there is a high-accuracy method, a simple method and a fast method available. The high-accuracy method is comparable to the measurement principle of the "Reeve" method, published in NBSIR 76-993 by NIST. In contrast to the "Reeve" method, the report of the deflection angle is defined according to ISO 10110.

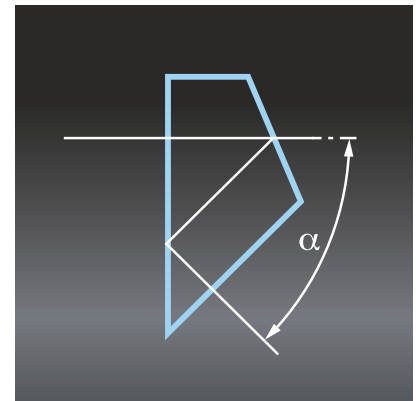

### Beam Splitter Cube Measurement

The angle of the internal surface of a beam splitter cube can be measured. The internal angles are determined by the evaluation of multiple reflections at the outer surfaces simultaneously with the outer geometry. The software can report the internal angle, the deflection angle in transmission and/or the deflection angle in reflection.

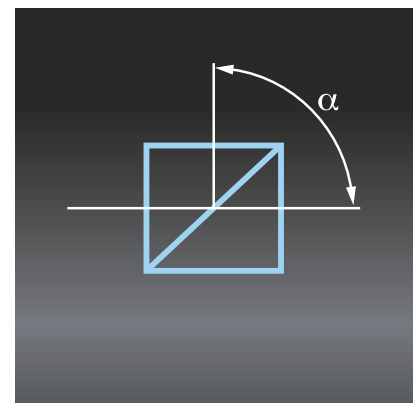

### Refractive Index Measurement

For the measurement of refractive index, two evaluation methods are available whose results are based on ray-tracing analysis. The first variant uses the Abbe method and is suitable for refractive angles up to  $42^\circ$ . The second variant uses a double-sided mirror to measure the deflection in transmission, but does not have to be performed at the minimum of deflection. The wavelength of the internal LED is used for measurement and the result is extrapolated to the C'-line. Optionally, a spectral lamp is available as illumination for precise measurements at other spectral lines.

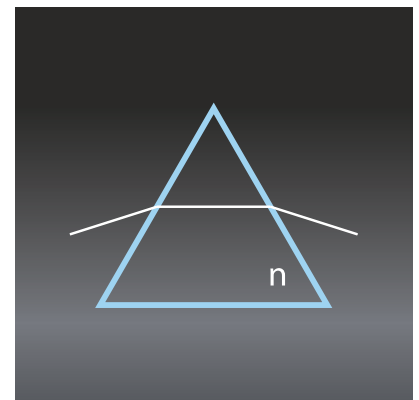

### Roof Edge Angle Measurement

A measurement at lacquered surfaces or at roof edges is possible with the roof mode. The measurement uses the information from internal reflections to determine the internal angles. The lacquer does not need to be removed, nor must there be anything attached to the highly sensitive roof edge. So this method alleviates difficulties for both incoming inspection of lacquered prisms and for inspection during production of roof edge prisms.

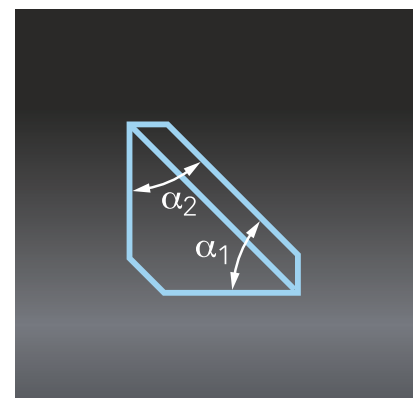

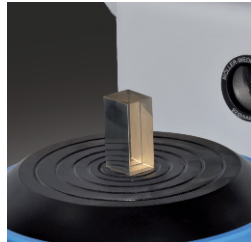
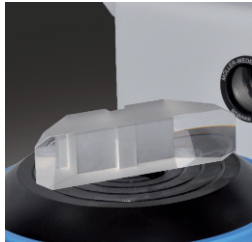
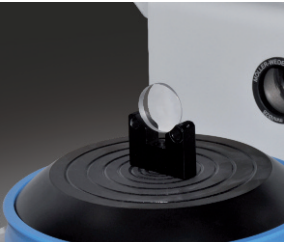
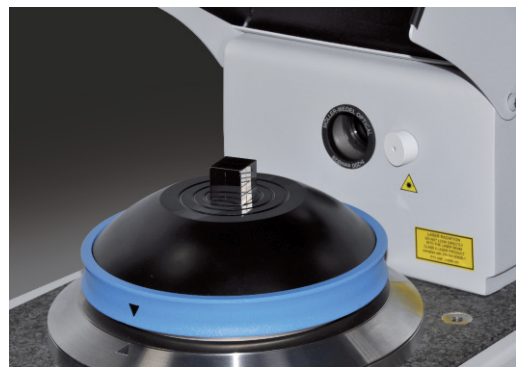
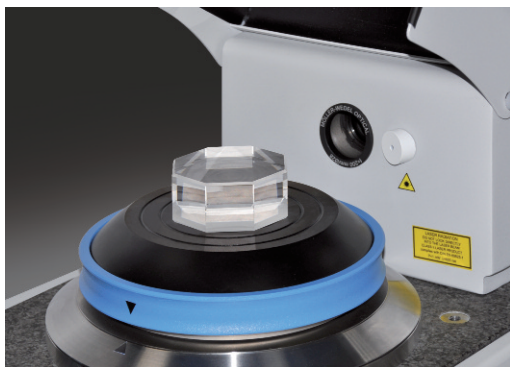
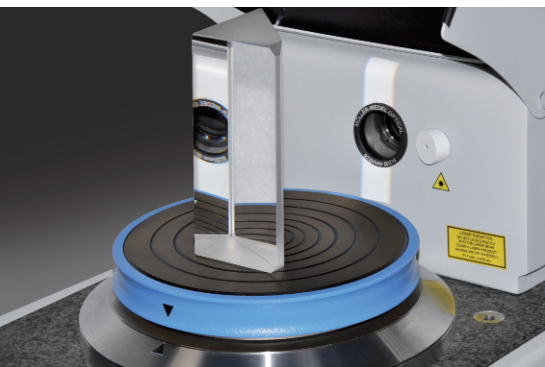
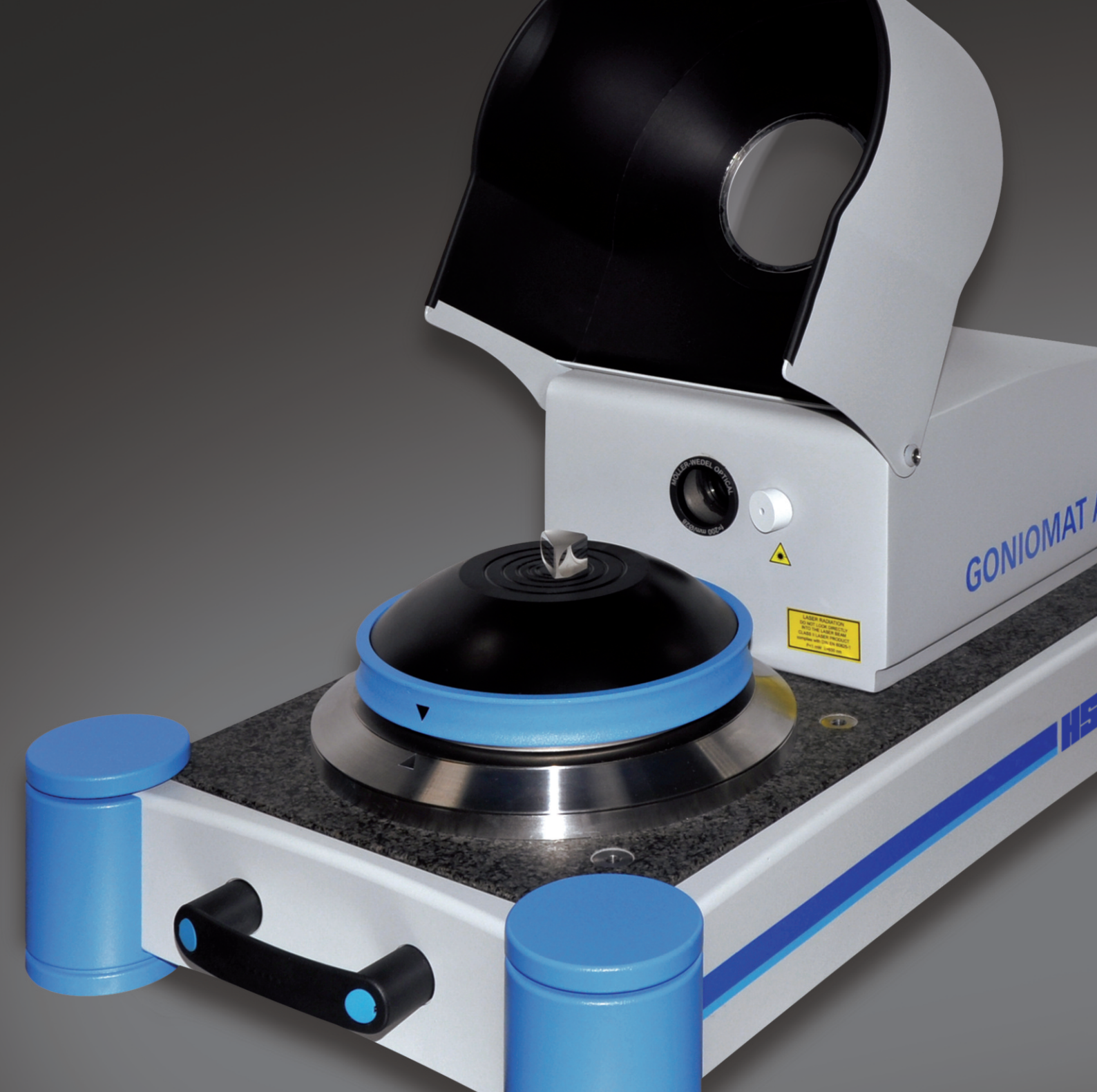

# GONIOMAT Product Line

## GONIOMAT M5, M5 XL, M10

The GONIOMAT M line enables easy handling of many specimen types and high accuracy by the combination of a manual precision rotary table and software-based evaluation of the autocollimation image in relation to the encoder position. These goniometers are ideal for incoming and outgoing inspection as well as for production control.

### Benefits:

- Short measurement times
- Objective measurement
- Logging of measurement results
- Easy handling
- Compact design for portability

### Measurement Principle:

The GONIOMAT M consists of a mechanical pivot-mounted rotary table (1), an angle encoder (2), an electronic autocollimator (3) and the GONIOMATIK software (4). The calculation of the autocollimation image position with respect to the rotary table position is done by the software. Therefore the surfaces need only to be coarsely aligned to the optical axis of the autocollimator.

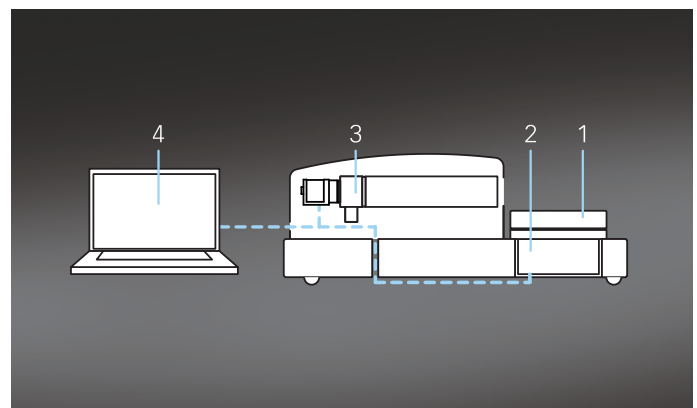

### Measurement Process:

1. Place specimen
2. Align first surface ① to the autocollimator
3. Choose measurement mode
4. Set measurement value of the first surface to zero
5. Align the next measuring surface ② to the autocollimator
6. Software displays angle measurement value

## GONIOMAT M5 / M10

The goniometers [GONIOMAT M5](#) and [M10](#) use different angle encoders and subsequently achieve different accuracies. Both variants benefit from the combination of modern USB-camera with [MÖLLER-WEDEL OPTICAL](#) standard components and the innovation of the software [GONIOMATIK](#).

### Features:

- Accuracy [GONIOMAT M5](#): 1.5"
- Accuracy [GONIOMAT M10](#): 2.5"
- Additional [support table H12](#) with three-point support
- Extension for measurement of micro prisms possible ([Alignment aid for micro prisms](#) / page 12)

Description	Art. No.
GONIOMAT M5	241 605
GONIOMAT M10	241 610



## GONIOMAT M5 XL

The [GONIOMAT M5 XL](#) is especially suited for measuring optical systems with large fixtures attached and other planar optical components up to a maximum diameter of 250 mm. The height of the optical axis is 90 mm. All other specifications are the same as the [GONIOMAT M5](#).

### Features:

- Accuracy class [GONIOMAT M5 XL](#): 1.5"
- Height of optical axis from rotary table: 90 mm
- Maximum specimen diameter: 250 mm

Description	Art. No.
GONIOMAT M5 XL	241 625

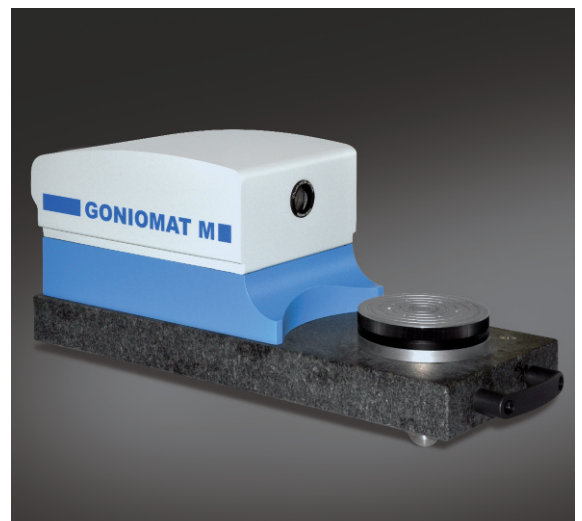

# GONIOMAT Product Line

## GONIOMAT A<sup>PLUS</sup>, A5

The GONIOMAT A line enables a fully-automatic measurement with the highest measurement accuracy by the combination of a motorized precision rotary table and software-based evaluation of the autocollimation image in relation to the encoder position. These goniometers are ideal for the inspection of specimens with high accuracy requirements and industrial volume production testing.

### Benefits:

- Highest measurement accuracy
- High reproducibility
- Maintenance- and backlash-free drive
- Objective measurements
- Highly-accurate measurement of pyramidal angles
- Fast measurement by hand is also possible
- Integrated aid for easy alignment of smallest specimen surfaces down to 0.5 mm<sup>2</sup>
- Logging of measurement results
- Easy handling
- Compact design for portability

### Measurement Principle:

The GONIOMAT A consists of a rotary table (1) with backlash-free drive (2), easily exchangeable support tables with kinematic mount, an angle encoder (3), an electronic autocollimator (4) with USB connection and the GONIOMATIK software (5).

The calculation of the autocollimation image position with respect to the rotary table position is done by the software. Therefore the surfaces need only to be coarsely aligned to the optical axis of the autocollimator.

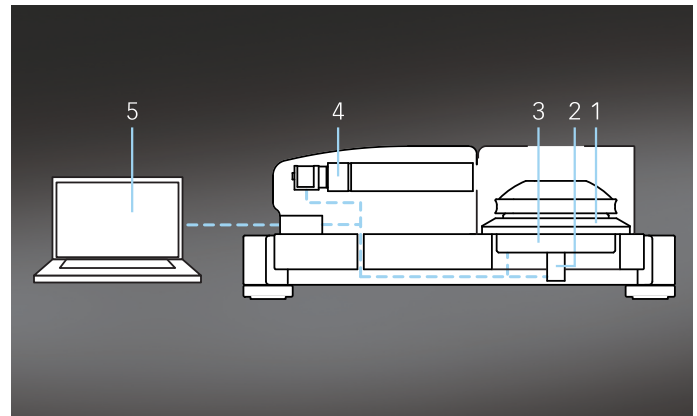

### Measurement Process:

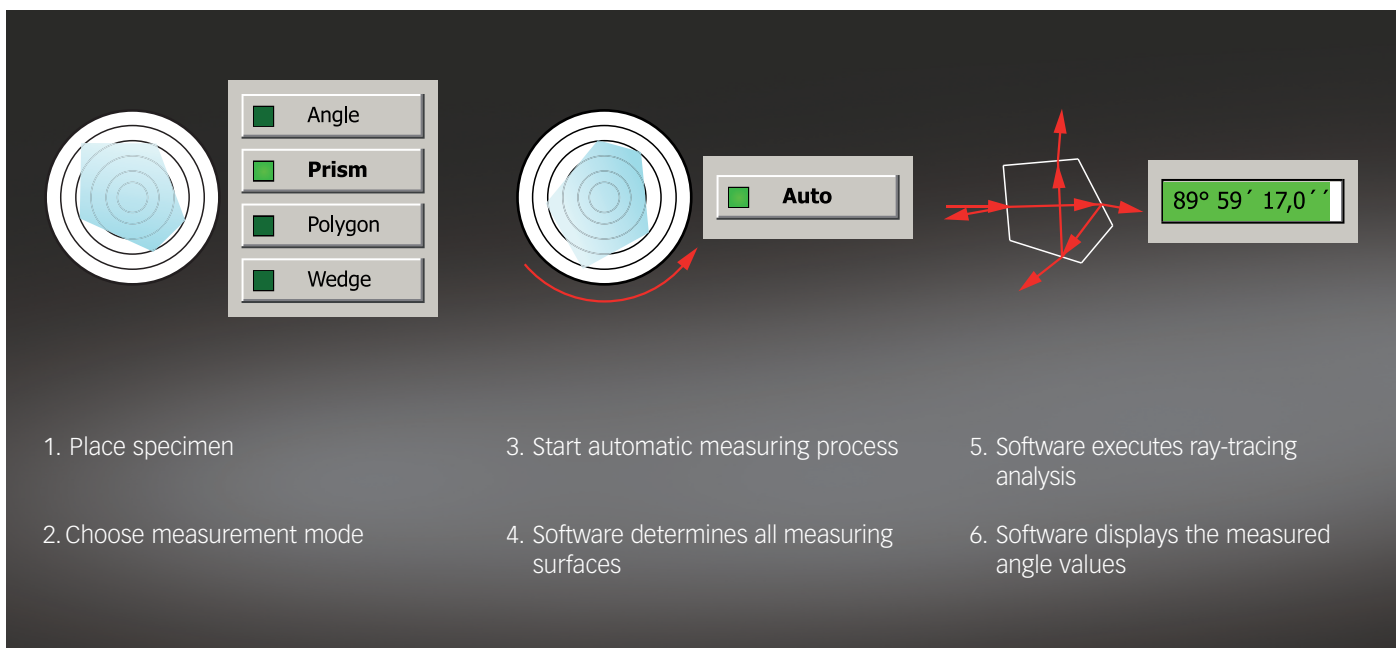



## GONIOMAT A<sup>PLUS</sup>

The innovative, fully automatic GONIOMAT A<sup>PLUS</sup> is distinguished by its highly precise bearing with backlash- and maintenance-free drive that reaches the same accuracy as a comparable air bearing. Thus the GONIOMAT A<sup>PLUS</sup> does not require any compressed air. So it is just as portable as the other goniometers.

### Features:

- Accuracy GONIOMAT A<sup>PLUS</sup>: 0.4"
- Precision bearing with backlash- and maintenance-free drive
- Fast adjustment to different specimen sizes by three exchangeable support tables with kinematic mount
- Integrated measuring cell
- Expanded refractive index measurement at different wavelengths with spectral unit (on request)

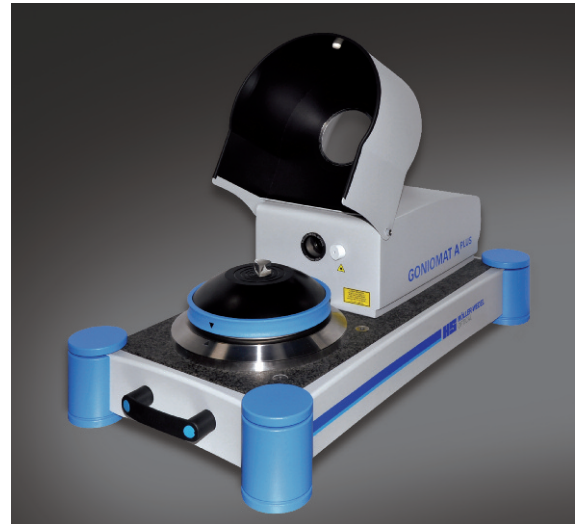

Description	Art. No.
GONIOMAT A PLUS	241 661

## GONIOMAT A5

The GONIOMAT A5 is based on the design of the GONIOMAT M and is equally compact, portable and flexible in use. With the motorized rotary table, the GONIOMAT A5 can measure autonomously, reliably and without intervention by a user. Thus it is suitable for fatigue-free repeated measurement. In addition, fast measurements are possible by manually turning the rotary table.

### Features:

- Accuracy GONIOMAT A5: 1.0"
- Additional support table H12 with three-point support
- Precision bearing with maintenance-free drive

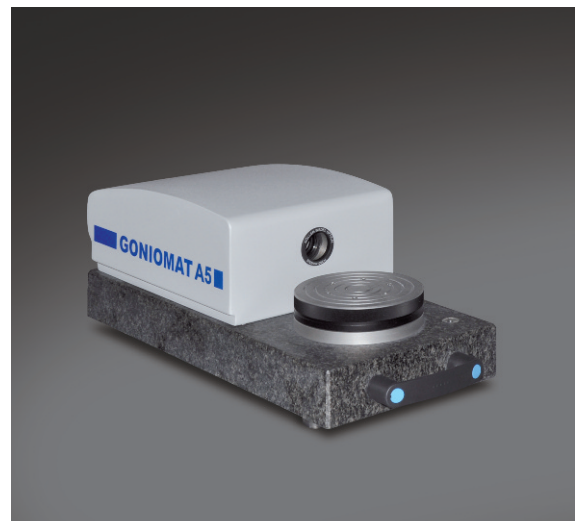

Description	Art. No.
GONIOMAT A5	241 631

# GONIOMAT Product Line

## GONIOMATIK Software

The software is an integral part of the GONIOMAT M and GONIOMAT A line. It distinguishes itself by a simple and well-thought-out operator interface and runs on WINDOWS® 7 and 10.

The software enables:

- Evaluation of measurements compliant to well-established standards (ISO 10110-1, VDI 2605, DIN 3140)
- Comprehensive logging of measurement results
- Presetting and monitoring of tolerances
- Innovative ray-tracing analysis

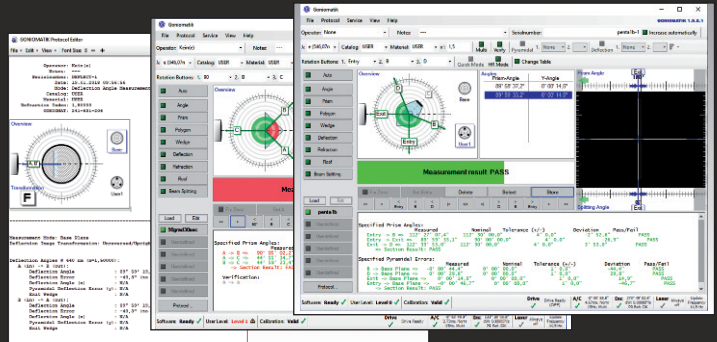

Additionally, the following software functions are integrated:

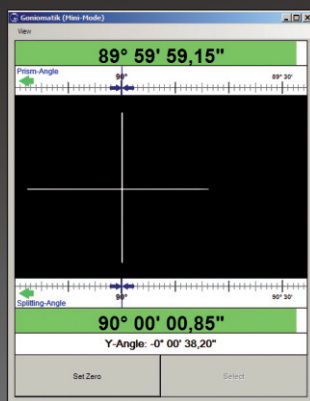
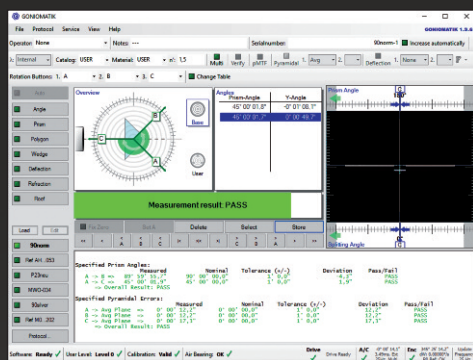

- Visualization of the autocollimation image and its deviation from the optical axis of the autocollimator
- Integration of position of encoder and of autocollimation image
- Consideration of the angle in y-direction for calculation of surface angles (virtual tilt table)
- Prediction of reflection according to measured geometry
- Automatic reflex selection and reconstruction by specimen geometry using a ray-tracing based method. It allows:
  - Trustworthy measurement without user intervention
  - Reliable discrimination of double or multiple reflections
  - Calculation of the theoretical deflection angles and the refractive index
- Measurement of the physical deflection angles
- Measurement of roof edge angles using method protected by a utility model\*
- Standard method for testing prisms, polygons and wedges
- Absolute testing of polygons according to the rosette method
- For simple routine measurements, the "mini-mode" with limited functionality is available

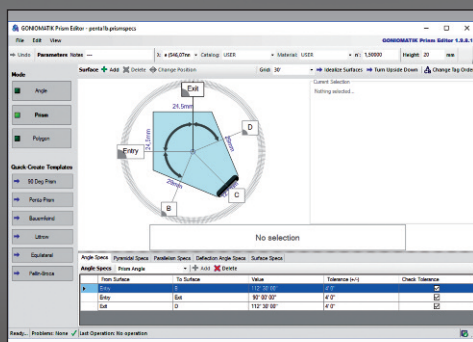

In the prism editor it is possible to create own prism specifications with the following:

- Specification of angles and tolerances
- Specification of pyramidal and deflection angles and parallelism
- Free naming of the specimen surfaces
- Preview of multiple internal reflections
- Specification of specimen sizes for correct ray-tracing analysis

# GONIOMAT Product Line

## Accessories in Scope of Delivery

### Angle Measurement Standard

Each GONIOMAT is supplied with an angle measurement standard for verification of the calibration status on-site.

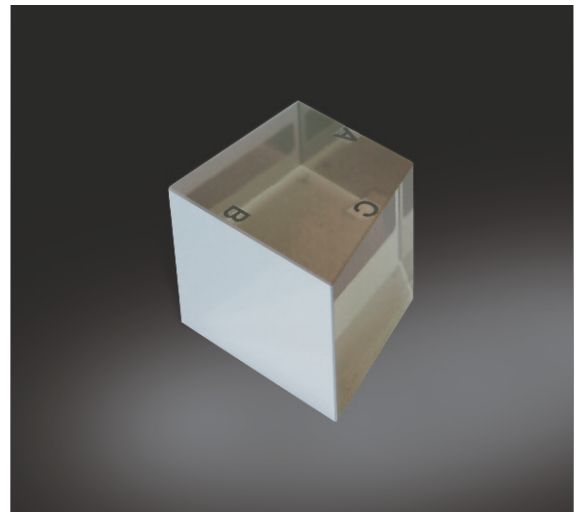

Description	Art.-No.
Angle Measurement Standard	241 612

### Support Table H12

Each GONIOMAT M5, M10 and A5 is delivered with a support table H12. This allows the reliable measurement of small prisms. The distance between the optical axis of the autocollimator and the rotary table surface is reduced by 12 mm.

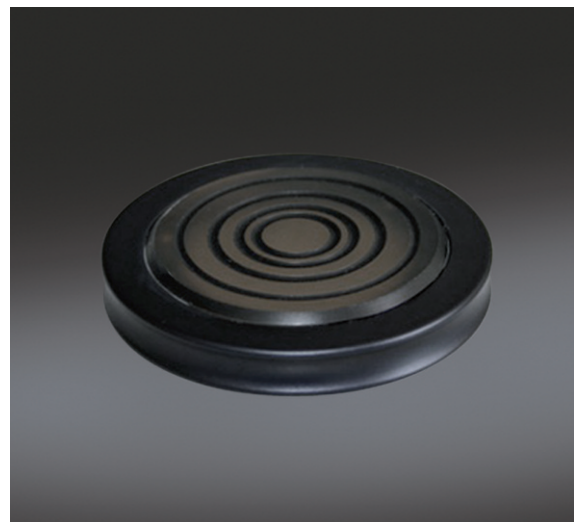

Description	Comment	Art.-No.
Support Table H12	For GONIOMAT M5, M10 and A5	241 611

### Support Table H20, H35, H45

Each GONIOMAT A<sup>PLUS</sup> is delivered with three support tables H20, H35 und H45. These allow the measurement of prisms of different sizes. The distance between the optical axis of the autocollimator and the rotary table surface is reduced by 20, 35 or 45 mm.

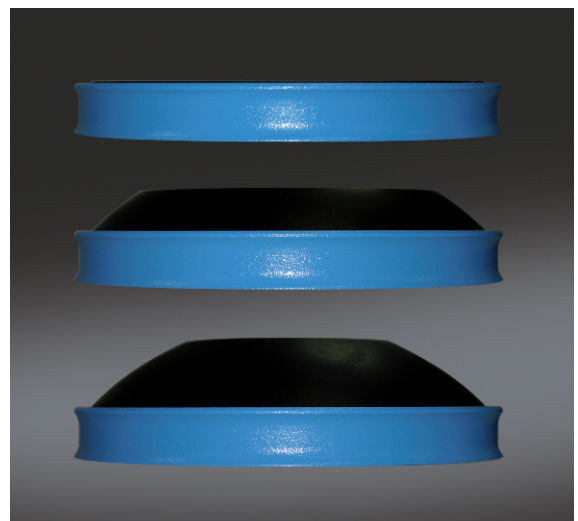

Description	Comment	Art.-No.
Support Table H20	For prisms of height > 30 mm	241 651
Support Table H35	For prisms of height from 10 to 40 mm	241 652
Support Table H45	For prisms of height < 15 mm	241 653

# GONIOMAT Product Line

## Accessories Optional

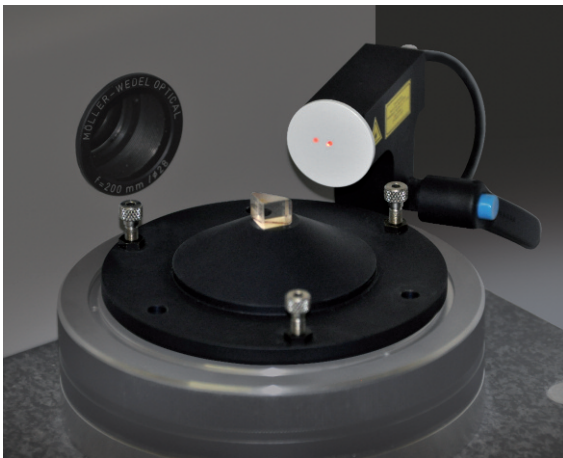

### Alignment Aid for Micro-Prisms

The alignment aid set for measurement of micro-prisms (down to 0.5 mm<sup>2</sup> surface area) simplifies the positioning of specimens to the autocollimator of GONIOMAT M in horizontal and vertical direction. The scope of delivery includes an alignment aid and a three-point tilt table for compensation of tilting angles of surfaces in the vertical direction.

Description	Comment	Art.-No.
Alignment Aid for Micro-Prisms	For GONIOMAT M	241 616

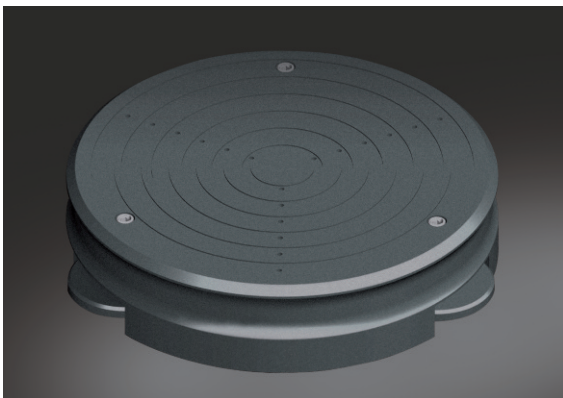

### Tilttable Support Table H35

With the tilttable support table, the user can measure prism faces with large production tolerances or a clear deviation from 90° to the base surface. It enables the compensation of pyramidal angles resulting in a tilt of the prism face.

Description	Comment	Art.-No.
Support Table H35, tilttable	For GONIOMAT A PLUS	241 666

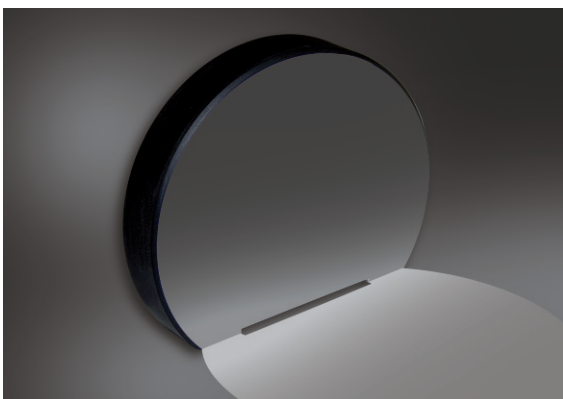

### Parallel Mirror 2" for Refractive Index Measurement

The refractive index measurement in Abbe-mode is possible for refractive angles up to  $\arcsin(1/n)$ . Thus, the refractive angle is limited to approximately 42°. For refractive angles between 40° and 60°, the refractive index has to be measured in "minimum of deflection" against a double-sided mirror.

Description	Comment	Art.-No.
Parallel Mirror	For GONIOMAT M and GONIOMAT A	280 803

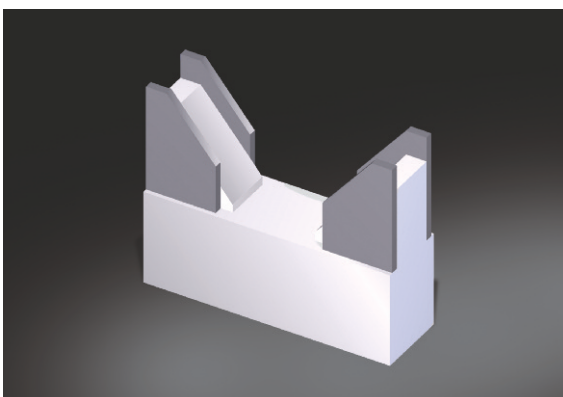

### V-Prism for Plane Plates and Wedges

The V-prism is suitable for secure mounting of wedges or plane plates in a diameter range from 40 to 60 mm. Alongside the determination of the wedge angle it is also possible to determine the angle deviation of each face of the part relative to the cylindrical axis of the part.

Description	Comment	Art.-No.
V-Prism	For GONIOMAT M and GONIOMAT A	280 624

# GONIOMAT Product Line

## Technical Data

<b>GONIOMAT</b>		<b>A<sup>PLUS</sup></b>	<b>A5</b>	<b>M5</b>	<b>M5 XL</b>	<b>M10</b>
Article No.		<b>241 661</b>	<b>241 631</b>	<b>241 605</b>	<b>241 625</b>	<b>241 610</b>
Measuring Range	degree	360	360	360	360	360
Accuracy (Multiple Measurement)**	arcsec	±0.4	±1.0	±1.5	±1.5	±2.5
Accuracy (Single Measurement)*	arcsec	±0.6	±1.5	±2.5	±2.5	±5.0
Accuracy (Pyramidal Angle Measurement)*	arcsec	±1.0	±3.0	±10.0	±10.0	±15.0
Operation Temperature	°C	20 ± 1	20 ± 1	20 ± 2	20 ± 2	20 ± 2
Minimum Surface Area (uncoated glass)	mm <sup>2</sup>	0.5	0.5	0.5	0.5	0.5
Maximum Specimen Diameter	mm	210	125	125	250	125
Maximum Specimen Weight	kg	10	10	10	10	10
Table Diameter	mm	160/122/85	125	125	125	125
Maximum Pyramidal Angle	arcmin	20	20	20	20	20
Autocollimator Focal Length	mm	200	200	200	200	200
Autocollimator Aperture	mm	28	28	28	28	28
Base Dimensions (without PC)	mm	610 x 340	530 x 200	530 x 200	560 x 200	530 x 200
Weight (without PC)	kg	35	19	19	26	19
PC-Connection		USB 3.0	USB 3.0	USB 3.0	USB 3.0	USB 3.0
Power Supply (Plug-In Power Supply Unit)						
Input Voltage	V/AC	100-240	100-240	100-240	100-240	100-240
Output Voltage	V/DC	24	24	12	12	12

\* According to DIN 1319, specimen  $\lambda/20$  p-v, 15 x 15 mm

\*\* According to DIN 1319, with multiple measurements at four positions offset by 90°; specimen  $\lambda/20$  p-v, 15 x 15 mm

**MÖLLER-WEDEL OPTICAL GmbH**

Rosengarten 10  
D-22880 Wedel

Tel.: +49 - 41 03 - 9 37 76 10  
Fax: +49 - 41 03 - 9 37 76 60

[www.moeller-wedel-optical.com](http://www.moeller-wedel-optical.com)  
e-mail: [info@moeller-wedel-optical.com](mailto:info@moeller-wedel-optical.com)